

MEASURING TECHNOLOGY & TEST SERVICE

Industry | Laboratory | Quality Assurance



2026

PROFESSIONAL MEASURING
SINCE 1844

It's so easy to order from SAUTER:

 Tel. +49 7433 9933-0

 E-Mail
info.sauter@kern-sohn.com

 Online Shop
www.kern-sohn.com

We look forward to meeting you
in our online shop – simply use
the QR Code:

Your Advantages – our Philosophy. All SAUTER Advantages at a Glance

Online Shop

www.kern-sohn.com

Convenient ordering or just to be inspired. You will find a huge selection of products and services in our online shop, 24/7.

Advice from the experts

Our SAUTER experts will offer you individual advice in a range of languages and will be pleased to assist you: Mon - Fri from 8.00 am to 5.00 pm

100 % product availability and dispatch service

With SAUTER you can be sure that you will have immediate access to the products you need – provided that they are in stock. Our 24-hour dispatch service will send your products immediately. Ordered today, on their way tomorrow!

Warranty

We offer you as the customer up to 3 years warranty on all products in our entire range, as an option the warranty can be extended for a small fee. Because our products deliver on their promises!

Customer service

Our customer service is personally available by telephone, e-mail or video call. We speak more than 7 languages and we will be happy to help with your requests.

Trust through experience

Experience counts: We are professionals when it comes to precision: A heavyweight in terms of measuring and weighing technology and this has been the case for 180 years – for the benefit of our customers. Put us to the test!

Accreditations/certification

- DAkkS accreditation
DIN EN ISO/IEC 17025
- Certified QM system DIN EN ISO 9001
- Conformity assessment in accordance with NAWID 2014/31/EU
- Medical certifications DIN EN ISO 13485 and 93/42/EEC or VO (EU) 2017/745

DAkkS-accredited calibrations

In the modern, accredited KERN calibration laboratory, we perform DAkkS-accredited calibrations for balances, test weights as well as for numerous other measuring devices. In addition we can offer calibrations on your premises. Of course, all services are in accordance with international standards.

Verification service

Our professional verification service offers conformity assessments and verification of balances and weights – for a feeling of security in compliance with legal requirements.

Individual customer solutions

We are the right partner for special customer requirements. SAUTER offers numerous modular system solutions for your very individual requirements. Please contact us!

Service Portal

You can find aftersales support in our online service portal: Technical Support, help with questions or problems, etc.
www.kern-sohn.com/shop/en/Serviceportal/

Spare parts and repair service

In spite of reliable SAUTER quality: If you should ever need to make a complaint about our products, we will help you quickly, flexibly and in an unbureaucratic manner.

No storage costs

You have no storage costs – we maintain the storage. Direct dispatch of ordered goods to your customer is available, invoice will be issued to you (third party business).

Still got questions?

[You can find all SAUTER Service Hotlines on the inside flap](#)

SAUTER Pictograms



External adjustment
Quick setting up of the balance's accuracy with external adjusting weight



Calibration block
Standard for adjusting or correcting the measuring device



Peak hold function
Capturing a peak value within a measuring process



Scan mode
Continuous capture and display of measurements



Push and Pull
The measuring device can capture tension and compression forces



Length measurement
Captures the geometric dimensions of a test object or the movement during a test process



Internal memory
Device memory capacity, e.g. for article data, measuring data, tare weights, PLU etc.



Data interface RS-232
To connect the device to a printer, PC or other peripherals. Suitable for data transfer over large distances. Network in bus topology is possible



Profinet
Enables efficient data exchange between decentralised peripheral devices (balances, measuring cells, measuring instruments etc.) and a control unit (controller).



USB data interface
To connect the measuring instrument to a printer, PC or other peripheral devices



Bluetooth® data interface
To transfer data to a printer, PC or other peripherals



WIFI data interface
To transfer data to a printer, PC or other peripherals



Control outputs (optocoupler, digital I/O)
To connect relays, signal lamps, valves, etc.



Analogue interface
To connect a suitable peripheral device for analogue processing of the measurements



Statistics
Using the saved values, the device calculates statistical data, such as average value, standard deviation etc.



PC Software
To transfer the measurement data from the device to a PC



Printer
A printer can be connected to the device to print out the measurement data



Network interface
For connecting the measuring device to an Ethernet network



KERN Communication Protocol (KCP)
A standardized interface command set for KERN balances and other instruments, which allows retrieving and controlling all relevant parameters and functions of the device. KERN devices featuring KCP are thus easily integrated with computers, industrial controllers and other digital systems



Units
Weighing units can be switched to e.g. non-metric. Please refer to website for more details



Mesuring with tolerance range
Upper and lower limiting can be programmed individually. The process is supported by an audible or visual signal, see the relevant model



Protection against dust and water splashes IPxx
The type of protection is shown in the pictogram



ZERO
Resets the display to "0"



Battery operation
Ready for battery operation. The battery type is specified for each device.



Rechargeable battery pack
Rechargeable set



Integrated power supply unit
Integrated, 230V/50Hz in EU. More standards e.g. GB, AUS or US on request



Motorised drive
The mechanical movement is carried out by a motor



Conformity assessment
The time required for conformity assessment is 3 working days



Accredited calibration (DAkkS) (DKD)
The time required for accredited calibration is 3 working days



Factory calibration (ISO)
The time required for factory calibration is 4 working days



Package shipment
The time required for internal shipping preparations is shown in days in the pictogram



Pallet shipment
The time required for internal shipping preparations is shown in days in the pictogram

SAUTER Models A-Z

281/285	7
283	8
287/289	6

A

AFH FAST	35
AFH LD	36
AFI-2.0	37

C

CB	84
CJ	88
CK	82
CP	80-81
CR	83
CS	86-87
CO	87
CT	85

D

DA	39
DB	40
DC Y1/-Y2	79

F

FA	9
FC	11
FC 1K-BT	21
FG	20
FH-M	13
FH-S	12
FK	10
FL-M	15
FL-S	14
FS	16-17
FS SET	18-19

H

HB	54
HD	55
HE	57
HK-D/-DB	60
HMM/-NP	61
HMO	63
HN-D	62
HO	66-67

J

JCS	76-77
JCT	45
JIT	69

S

S71	24
SO	70
SP	71
SU	72
SW	73-74

T

TB	42
TB-US	47
TD-US	48
TE	43
TG	44
TI	56
TI-HE	58
TN GOLD	49
TN-EE	51
TN-US	50
TO-EE	52
TVL/-E/-O/-XLS	22
TVM-N/-NL/-LB	28-29
TVO	25
TVO-S/-LD	26-27
TVP/-L	23
TVO <small>NEW</small>	32
TVS/-LD	30-31

SAUTER Customer Consultants

With questions about our products and services, we will be happy to advise you:

UK, IE, BE, LU, IS, IT, MT



Fabiana Schmid
Area Sales Manager
Tel. +49 7433 9933-387
Mobil +49 151 46143240
fabiana.schmid@kern-sohn.com

DK, SE, FI, NO, NL



Hanna Blackschleger
Area Sales Manager
Tel. +49 7433 9933-305
Mobil +49 171 3031168
hanna.blackschleger@kern-sohn.com

PL, LV, LT, EE, SK, CZ, HU



Mark Hauder
Area Sales Manager
Tel. +49 7433 9933-310
Mobil +49 160 3378426
mark.hauder@kern-sohn.com

SL, HR, AL, MK, BG, BA, ME, RO, GR, CY, GUS



Anna-Maria Ruoff
Area Sales Manager
Tel. +49 7433 9933-316
Mobil +49 171 3059661
anna-maria.ruoff@kern-sohn.com

North America, Africa, Asia, Middle East, Oceania, TR



Corinna Matthes
Area Sales Manager
Tel. +49 7433 9933-215
Mobil +49 151 44568364
corinna.matthes@kern-sohn.com

Product Specialist Measuring Technology



Irmgard Russo
Tel. +49 7433 9933-208
info.sauter@kern-sohn.com

Product Specialist Measuring Technology



Helga Biselli
Tel. +49 7433 9933-188
info.sauter@kern-sohn.com

Category Manager Industrial Measuring Technology



Michael Stingel
Tel. +49 7433 9933-293
michael.stingel@kern-sohn.com

Sales & Marketing Manager



Stephan Ade
Tel. +49 7433 9933-121
Mobil +49 171 3060086
ade@kern-sohn.com

SAUTER Hotlines



Technical questions about our products?

You will find assistance here quickly: **+49 7433 9933- ...**

Service Hotline

for general technical questions about your SAUTER product

→ **199**

SAUTER Measuring Instruments

for all technical questions concerning our SAUTER measuring instruments, test benches, force measuring accessories (clamps etc.), SAUTER software

→ **555**

Industrial Scales

for all technical questions concerning our basic scales (laboratory & industry), pocket balances, school balances, bench scales, price-computing scales, platform scales, counting scales, counting systems, floor scales, pallet truck scales, crane scales, veterinary scales

→ **333**

System Solutions Industry 4.0

for all technical questions concerning the interlocking of the latest information and communication technology with our scales, load cells and measuring devices as well as questions about KERN software

→ **200**

Product Group Index 2026

Force Measurement

1

05–37



Torque Measurement

2

38–40



Coating Thickness Measurement

3

41–45



Material Thickness Measurement

4

46–52



Hardness Testing of Plastics (Shore)

5

53–58



Hardness Testing of Metals (Leeb)

6

59–63



Hardness Testing of Metals (UCI)

7

65–67



Occupational Safety, Environment

8

68–74



Colour Measurement

9

75–77



Load Cells

10

78–88



Calibration Service

89–90



NEW IN → 2026

Discover our SAUTER products – developed for maximum versatility and modern applications.
Innovative technology meets intelligent solutions for tomorrow's requirements.

NEW

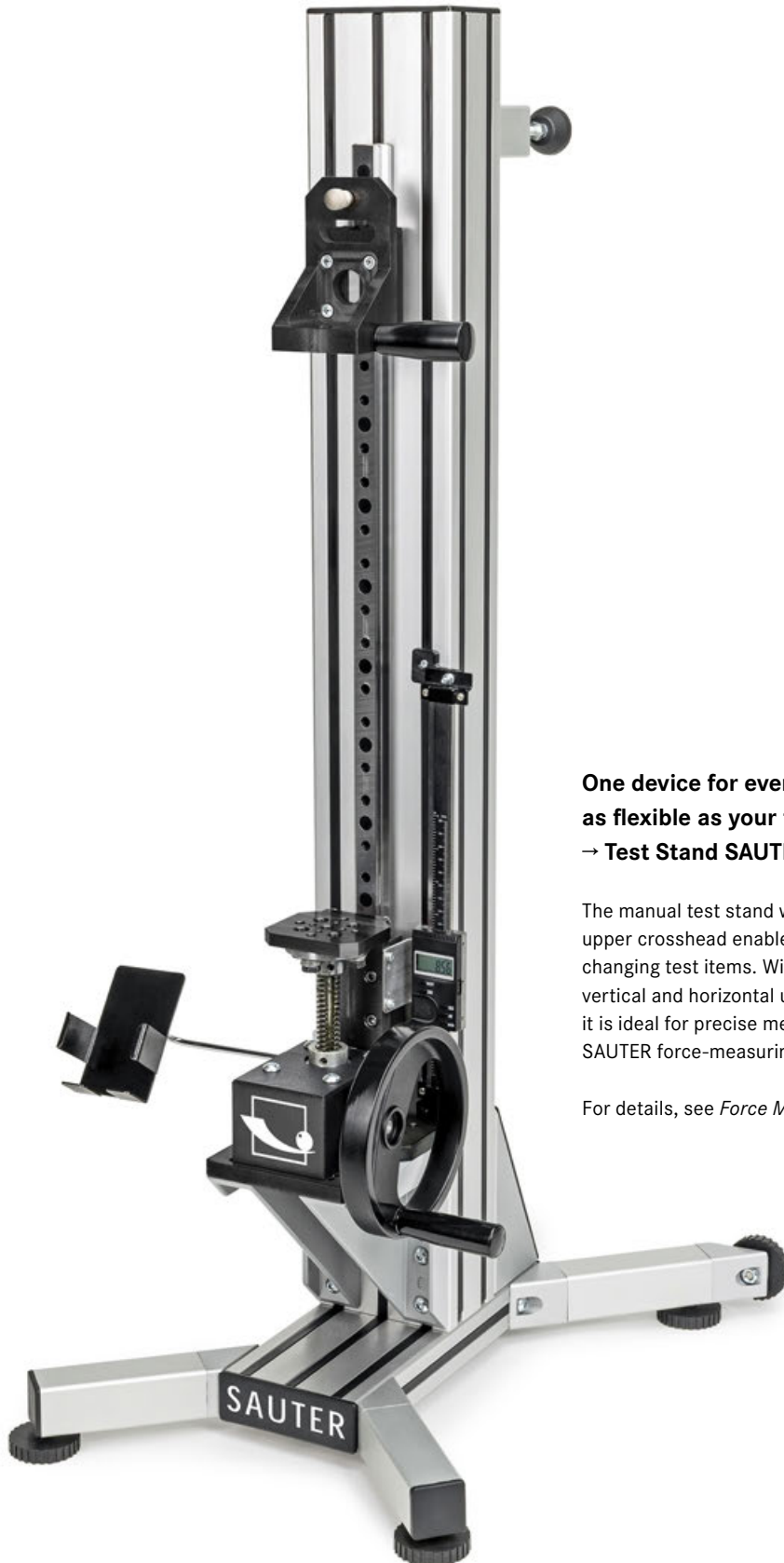

**One device for everything –
as flexible as your test items
→ Test Stand SAUTER TVQ**

The manual test stand with integrated quick adjustment of the upper crosshead enables easy height adjustment – ideal when changing test items. With a maximum force of up to 7 kN, flexible vertical and horizontal use and an expandable modular system, it is ideal for precise measuring tasks in combination with all SAUTER force-measuring devices.

For details, see *Force Measurement*



Irmgard Russo
 Product Specialist
 Force Measurement
 Tel. +49 7433 9933-208
 info@sauter.eu



FORCE MEASUREMENT

Quick-Finder

Readout	Measuring range [Max]	Model	Price excl. of VAT ex works €	Page
[d]	N	SAUTER		
0,001	2	FH 2	590,-	12
0,001	5	FH 5	590,-	12
0,002	5	FL 5	570,-	14
0,004	20	FS 2-20	1070,-	16
0,004	20	FS 4-20	1180,-	16
0,005	10	FH 10	590,-	12
0,005	10	FK 10	285,-	10
0,005	10	FL 10	570,-	14
0,01	1	283-152	117,-	8
0,01	10	FC 10	415,-	11
0,01	20	FH 20	590,-	12
0,01	25	FK 25	285,-	10
0,01	25	FL 20	570,-	14
0,01	50	FC 50	415,-	11
0,01	50	FH 50	590,-	12
0,01	50	FS 2-50	1070,-	16
0,01	50	FS 4-50	1180,-	16
0,01 0,05	1	289-100	81,-	6
0,02	3	283-252	130,-	8
0,02	50	FK 50	285,-	10
0,02	50	FL 50	570,-	14
0,02	100	FS 2-100	1070,-	16
0,02	100	FS 2-100OY2	1320,-	18
0,02	100	FS 4-100	1180,-	16
0,04	200	FS 2-200	1070,-	16
0,04	200	FS 4-200	1180,-	16
0,05	6	283-302	130,-	8
0,05	10	FA 10	240,-	9
0,05	100	FH 100	590,-	12
0,05	100	FK 100	285,-	10
0,05	100	FL 100	570,-	14
0,05 0,5	5	289-102	81,-	6
0,1	10	283-402	127,-	8
0,1	20	FA 20	240,-	9
0,1	100	FC 100	415,-	11
0,1	200	FH 200	590,-	12
0,1	250	FK 250	285,-	10
0,1	250	FL 200	570,-	14
0,1	500	FC 500	415,-	11
0,1	500	FH 500	590,-	12
0,1	500	FH 500S71	710,-	24
0,1	500	FS 2-500	1070,-	16
0,1	500	FS 2-500OY1	1250,-	18
0,1	500	FS 2-500OY2	1320,-	18
0,1	500	FS 4-500	1180,-	16
0,1	500	FS 500G	1160,-	20
0,1	500	FS 500G	1160,-	20
0,1	500	TVL 500FHS71	1380,-	24
0,1 0,5	10	289-104	92,-	6
0,2	25	283-422	134,-	8
0,2	500	FK 500	285,-	10

Readout	Measuring range [Max]	Model	Price excl. of VAT ex works €	Page
[d]	N	SAUTER		
0,2	500	FL 500	570,-	14
0,2	500	FL 500G	690,-	20
0,2	500	FL 500G	690,-	20
0,2	500	FL 500G	690,-	20
0,2	1000	FS 2-1KOY2	1390,-	18
0,2	1000	FS 2-1KSP1	1300,-	18
0,25	50	FA 50	240,-	9
0,4	2000	FS 2-2KOY1	1260,-	18
0,5	50	283-483	255,-	8
0,5	100	FA 100	240,-	9
0,5	1000	FH 1K	1000,-	13
0,5	1000	FK 1K	285,-	10
0,5	1000	FL 1K	650,-	14
0,5	1000	FL 1KG	810,-	20
0,5	1000	FL 1KG	810,-	20
0,5	1000	FL 1KG	810,-	20
0,5	2500	FS 2-2KSP1	1300,-	18
1	100	283-502	260,-	8
1	200	FA 200	240,-	9
1	1000	FC 1K	415,-	11
1	1000	FC 1K-BT	1320,-	21
1	2000	FH 2K	1000,-	13
1	2500	FL 2K	820,-	15
1	5000	FH 5K	1270,-	13
1	5000	FS 2-5KOY1	1320,-	18
1	5000	FS 2-5KRY1	1380,-	18
1	5000	FS 2-5KSP1	1320,-	18
2	200	283-602	270,-	8
2	5000	FL 5K	890,-	15
2	10000	FS 2-10KRY1	1390,-	18
2	10000	FS 2-10KSP1	1390,-	18
2,5	500	FA 500	240,-	9
2,5	500	FA 500G	355,-	20
2,5	500	FA 500G	355,-	20
2,5	500	FA 500G	355,-	20
4	20000	FS 2-20KOY1	1350,-	18
4	20000	FS 2-20KSP1	1390,-	18
5	500	283-902	320,-	8
5	10000	FH 10K	1360,-	13
5	10000	FL 10K	990,-	15
5	25000	FS 2-25KRO1	1410,-	18
10	20000	FH 20K	1370,-	13
10	20000	FL 20K	990,-	15
10	50000	FH 50K	1600,-	13
10	50000	FS 2-50KRO1	1410,-	18
10	50000	FS 2-50KRY1	1410,-	18
10	50000	FS 2-50KSP1	1410,-	18
20	100000	FS 2-100KRO1	1430,-	18
20	100000	FS 2-100KRY1	1570,-	18
20	100000	FS 2-100KSP1	1690,-	18
40	200000	FS 2-200KRY1	1610,-	18
50	100000	FH 100K	1680,-	13



SAUTER 289



SAUTER 287

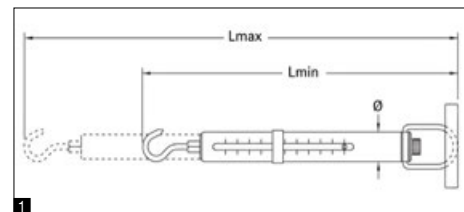

Discover more details and matching accessories online!

Mechanical weight and force measurement with quality spring for long service life

Features

- The very best price/performance ratio thanks to the transparent plastic housing, ideal for schools and educational institutions
- Newton scale: The SAUTER 289 range can display the results in Newtons instead of in grammes, specifically for measuring tensile forces
- Double scale: For fast or precise recording of the measurement result
- Backlash-free spring bearing with integrated tare screw for highly-precise adjustment
- Non-fatigue stainless steel spring

- Abrasion-resistant, colour precision scale with high resolution
- Thanks to the rotating inner tube, the scale is always easy to read
- The bracket which is delivered as standard can easily be swapped for another suspension device, so that the system can be individually adapted to the items being weighed

Technical data

- Measuring precision: $\pm 0,3\%$ of [Max]
- Tare range: 20 % of [Max]



Model	Measuring range [Max]	Division [d]	Load Support	1 Dimensions			Price excl. of VAT ex works €	Option	
				Lmin	Lmax	Ø		Factory calibration certificate	
SAUTER	N	N		mm	mm	mm		KERN	€
289-100	1	0,01 0,05	Hook	230	335	12,2	81,-	961-1610	195,-
289-102	5	0,05 0,5	Hook	230	335	12,2	81,-	961-1610	195,-
289-104	10	0,1 0,5	Hook	235	335	12,2	92,-	961-1610	195,-

Model	Measuring range [Max]	Division [d]	Load Support	1 Dimensions			Price excl. of VAT ex works €	Option	
				Lmin	Lmax	Ø		Factory calibration certificate	
SAUTER	g	g		mm	mm	mm		KERN	€
287-100	10	0,1	Clip	225	330	12,2	85,-	961-100	103,-
287-102	20	0,2	Clip	225	330	12,2	82,-	961-100	103,-
287-104	50	0,5	Clip	225	330	12,2	82,-	961-100	103,-
287-106	100	1	Clip	225	330	12,2	82,-	961-100	103,-
287-108	500	5	Clip	225	330	12,2	82,-	961-100	103,-
287-110	1000	10	Clip	225	330	12,2	93,-	961-100	103,-



SAUTER 281



SAUTER 285

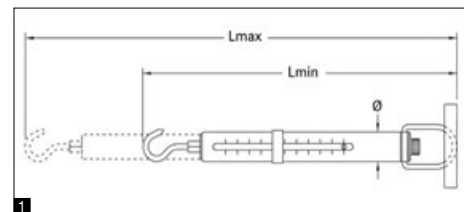

1

Discover more details and matching accessories online!

Precise, mechanical spring balances in robust aluminium housing with g/kg readout

Features

- Aluminium scale tube: robust, long service life, handy
- Gram/Kilogram scale: Measuring result display in grams/kilograms instead of N
- Double scale: For fast or precise recording of the measurement result
- Compressive force measurement: possible using an optional pressure set, see accessories
- Drag pointer and carrying handle: as standard for all models of the SAUTER 285 range

- Thanks to the rotating suspension bow the scale can always be aligned to be at the very best line of sight
- Backlash-free spring bearing with integrated tare screw for highly-precise adjustment
- Non-fatigue stainless steel spring
- Clip loop which can be freely rotated of the lower suspension bracket by 360° for models with [Max] ≤ 1 kg
- High-quality workmanship: Wear-resistant, colour-anodised precision scale with high resolution for accurate readability of the measuring result

Technical data

- Measuring precision: ± 0,3 % of [Max]
- Tare range: 20 % of [Max]



Model	Weighing range [Max]	Division [d]	Load support	1 Dimensions			Price excl. of VAT ex works	Option	
				Lmin	Lmax	Ø		Factory calibration certificate	
SAUTER	g	g		mm	mm	mm	€	KERN	€
281-101	10	0,1	Clip	220	300	12	122,-	961-100	103,-
281-151	30	0,25	Clip	220	300	12	107,-	961-100	103,-
281-201	60	0,5	Clip	220	300	12	107,-	961-100	103,-
281-301	100	1	Clip	220	300	12	108,-	961-100	103,-
281-401	300	2	Clip	225	325	12	122,-	961-100	103,-
281-451	600	5	Clip	225	325	12	130,-	961-100	103,-
281-601	1000	10	Clip	225	325	12	147,-	961-100	103,-
281-752	2500	20	Hook	225	325	12	137,-	961-100	103,-
285-052	5000	50	Hook	370	510	32	250,-	961-100	103,-
285-102	10000	100	Hook	370	510	32	270,-	961-101	128,-
285-202	20000	200	Hook	370	510	32	265,-	961-101	128,-
285-352	35000	500	Hook	370	460	32	270,-	961-101	128,-
285-502	50000	500	Hook	370	460	32	320,-	961-101	128,-

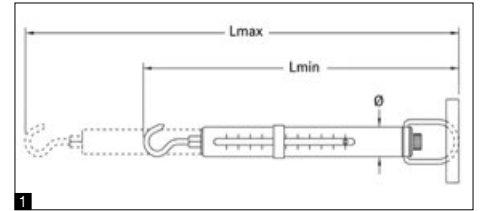

Discover more details and matching accessories online!

Precise, mechanical force gauge in robust aluminium housing with Newton readout

Features

- Aluminium scale tube: robust, long service life, handy
- Newton scale: Measuring result displayed in Newton
- Double scale: For fast or precise recording of the measurement result
- Compressive force measurement: possible using an optional pressure set, see accessories
- Carrying handle as standard
- Drag pointer as standard on all models of the SAUTER 283 range with [Max] \geq 50 N

- Thanks to the rotating suspension bow the scale can always be aligned to be at the very best line of sight on all models of the SAUTER 283 range with [Max] \geq 50 N
- Backlash-free spring bearing with integrated tare screw for highly-precise adjustment
- Non-fatigue stainless steel spring
- Clip loop which can be freely rotated of the lower suspension bracket by 360°
- High-quality workmanship: Wear-resistant, colour-anodised precision scale with high resolution for accurate readability of the measuring result

Technical data

- Measuring precision: $\pm 0,3\%$ of [Max]
- Tare range: 20 % of [Max]

STANDARD



OPTION



Model	Measuring range [Max] N	Division [d] N	Load support	1 Dimensions			Price excl. of VAT ex works €	Option	
				Lmin	Lmax	Ø		Factory calibration certificate	KERN
SAUTER									
283-152	1	0,01	Hook	225	305	12	117,-	961-1610	195,-
283-252	3	0,02	Hook	225	325	12	130,-	961-1610	195,-
283-302	6	0,05	Hook	225	325	12	130,-	961-1610	195,-
283-402	10	0,1	Hook	225	325	12	127,-	961-1610	195,-
283-422	25	0,2	Hook	225	325	12	134,-	961-1610	195,-
283-483	50	0,5	Hook	370	510	32	255,-	961-1610	195,-
283-502	100	1	Hook	370	510	32	260,-	961-1610	195,-
283-602	200	2	Hook	370	510	32	270,-	961-1610	195,-
283-902	500	5	Hook	370	510	32	320,-	961-1610	195,-

FACE
LIFT



1



Discover more details and matching accessories online!

Mechanical force gauge with peak-hold function; new with sturdy aluminium housing and modern design

Features

- Mechanical force gauge for tensile and compressive force measurements
- Sturdy aluminium housing to protect the mechanics in the event of knocks or falls
- Modern, functional design
- Dual scale: shows Newton and kg
- Turnable display unit for an easy zero setting of the instrument
- Peak hold function by drag pointer
- Can be mounted on all manual test stands
- Zeroing by a short push of the switch
- **1** Standard attachments as shown, extension rod: 90 mm

Technical data

- Measuring precision: 1 % of [Max]
- Overall dimensions W×D×H 233×66×53 mm
- Thread: M6
- Net weight approx. 0,60 kg

STANDARD



OPTION



Model	Measuring range [Max] N	Division [d] N	Price excl. of VAT ex works €	Option Factory Calibration Certificate					
				Tensile Force		Compressive Force		Tensile/Compressive Force	
SAUTER			€	KERN	€	KERN	€	KERN	€
FA 10	10	0,05	240,-	961-1610	195,-	961-2610	205,-	961-3610	365,-
FA 20	20	0,1	240,-	961-1610	195,-	961-2610	205,-	961-3610	365,-
FA 50	50	0,25	240,-	961-1610	195,-	961-2610	205,-	961-3610	365,-
FA 100	100	0,5	240,-	961-1610	195,-	961-2610	205,-	961-3610	365,-
FA 200	200	1	240,-	961-1610	195,-	961-2610	205,-	961-3610	365,-
FA 500	500	2,5	240,-	961-1610	195,-	961-2610	205,-	961-3610	365,-

Further calibration options on request



Discover more details and matching accessories online!

Robust, digital force gauge for tensile and compressive force measurements

Features

- Turnable display: automatic direction identification
- Secure operability due to the ergonomic design
- Peak-Hold function to capture peaks (value is "frozen" for approx. 10 seconds) or Track function mode for a continuous measurement indication
- Selectable measuring units: N, lbf, kg, ozf
- Auto-Power-Off
- **1** Standard attachments as shown, extension rod: 90 mm
- Can be mounted on all SAUTER test stands up to 5 kN

Technical data

- Measuring precision: 0,5 % of [Max]
- Overload protection: 200 % of [Max]
- Overall dimensions W×D×H 195×83×35 mm
- Thread: M8
- Ready for use: Batteries included, 6×1.5 V AA
- Net weight approx. 0,75 kg

STANDARD



OPTION



Model	Measuring range [Max]	Readability [d]	Price excl. of VAT ex works €	Option Factory Calibration Certificate					
				Tensile Force		Compressive Force		Tensile/Compressive Force	
SAUTER	N	N	€	KERN	€	KERN	€	KERN	€
FK 10	10	0,005	285,-	961-1610	195,-	961-2610	205,-	961-3610	365,-
FK 25	25	0,01	285,-	961-1610	195,-	961-2610	205,-	961-3610	365,-
FK 50	50	0,02	285,-	961-1610	195,-	961-2610	205,-	961-3610	365,-
FK 100	100	0,05	285,-	961-1610	195,-	961-2610	205,-	961-3610	365,-
FK 250	250	0,1	285,-	961-1610	195,-	961-2610	205,-	961-3610	365,-
FK 500	500	0,2	285,-	961-1610	195,-	961-2610	205,-	961-3610	365,-
FK 1K	1000	0,5	285,-	961-1620	250,-	961-2620	250,-	961-3620	450,-

1 ONLY WHILE STOCKS LAST
Further calibration options on request



Discover more details and matching accessories online!

Compact force gauge for tensile and compressive force measurements

Features

- Turnable display with backlight
- Peak-Hold function to capture the peak value or Track function for continuous display of measurement
- Metal housing for durable use in harsh environmental conditions
- Capacity display: A bar lights up to show how much of the measuring range is still available
- Measuring with tolerance range (limit-setting function): Upper and lower limit adjustable, between 10 and 100 % of [Max], in pull and push direction. The process is supported by an acoustic and visual signal

- Safety: If loads exceed 110 % of the measuring range, the device will give clear acoustic and visual signals
- Internal memory for up to 500 measurement values
- USB data interface and USB interface cable as standard
- Selectable: AUTO-OFF function or permanent operation
- Selectable measuring units: N, kgf, ozf, lbf
- 1 Delivered in a robust carrying case
- 2 Standard attachments as shown, extension rod: 90 mm
- Can be mounted on all SAUTER test stands up to 5 kN

Technical data

- Measuring precision: 0,3 % of [Max]
- Transmission rate to PC: Up to 200 measured values/second
- Overload protection: 150 % of [Max]
- Overall dimensions W×D×H 145×73×34 mm
- Thread: M6
- Rechargeable battery pack integrated, as standard, operating time up to 20 h without backlight, charging time approx. 4 h
- Net weight approx. 0,50 kg

STANDARD



OPTION



Model	Measuring range [Max] N	Readability [d] N	Price excl. of VAT ex works €	Option Calibration certificate					
				Tensile Force		Compressive Force		Tensile Force	Compressive Force
				DAkKS accr. KERN	€	DAkKS accr. KERN	€	DAkKS accr. KERN	€
SAUTER FC 10	10	0,01	415,-	963-161	195,-	963-261	195,-	963-361	355,-
FC 50	50	0,01	415,-	963-161	195,-	963-261	195,-	963-361	355,-
FC 100	100	0,1	415,-	963-161	195,-	963-261	195,-	963-361	355,-
FC 500	500	0,1	415,-	963-161	195,-	963-261	195,-	963-361	355,-
FC 1K	1000	1	415,-	963-162	235,-	963-262	235,-	963-362	440,-

Further calibration options on request



Discover more details and matching accessories online!

Universal digital force gauge for tensile and compressive force measurements with integrated load cell

Features

- Turnable display with backlight
 - **1** Can be mounted on all SAUTER test stands up to 5 kN
 - **2** USB interface for data transfer and power supply as standard
 - Data interface RS-232 as standard
 - Selectable measuring units: N, kgf, lbf
 - Peak-Hold function to capture the peak value or Track function for continuous display of measurement
 - Measuring with tolerance range (limit-setting function): Upper and lower limit adjustable, in pull and push direction.
- The process is supported by an audible and visual signal

- Auto-Power-Off
- Internal memory for up to 10 measurement values
- Mini Statistics Kit: calculates the average result from up to 10 stored measured values, as well as min., max., n
- **3** Standard attachments as shown, extension rod: 90 mm, included with the delivery
- **4** Delivered in a robust carrying case

Technical data

- Transfer rate to PC: approx. 25 measured values per second
- Measuring precision: 0,5 % of [Max]
- Overload protection: 150 % of [Max]
- Thread: M6
- Overall dimensions W×D×H 240×70×40 mm
- Rechargeable battery pack integrated, as standard, operating time up to 40 h without backlight, charging time approx. 120 min
- External mains adapter, for connection to the USB-C connector, standard
- Net weight approx. 0,55 kg

STANDARD



OPTION



Model	Measuring range [Max] N	Readability [d] N	Price excl. of VAT ex works €	Option Calibration certificate					
				Tensile Force		Compressive Force		Tensile/Compressive Force	
				DAkkS accr. KERN	€	DAkkS accr. KERN	€	DAkkS accr. KERN	€
SAUTER FH 2	2	0,001	590,-	-	-	-	-	-	-
SAUTER FH 5	5	0,001	590,-	-	-	-	-	-	-
SAUTER FH 10	10	0,005	590,-	963-161	195,-	963-261	195,-	963-361	355,-
SAUTER FH 20	20	0,01	590,-	963-161	195,-	963-261	195,-	963-361	355,-
SAUTER FH 50	50	0,01	590,-	963-161	195,-	963-261	195,-	963-361	355,-
SAUTER FH 100	100	0,05	590,-	963-161	195,-	963-261	195,-	963-361	355,-
SAUTER FH 200	200	0,1	590,-	963-161	195,-	963-261	195,-	963-361	355,-
SAUTER FH 500	500	0,1	590,-	963-161	195,-	963-261	195,-	963-361	355,-

Further calibration options on request



Discover more details and matching accessories online!

Universal digital force gauge for tensile and compressive force measurements with external load cell

Features

- Turnable display with backlight
- **1** USB interface for data transfer and power supply as standard
- Data interface RS-232 as standard
- Selectable measuring units: N, kN, kgf, tf
- Peak-Hold function to capture the peak value or Track function for continuous display of measurement
- Measuring with tolerance range (limit-setting function): Upper and lower limit adjustable, in pull and push direction.
The process is supported by an audible and visual signal

- Auto-Power-Off
- Internal memory for up to 10 measurement values
- Mini Statistics Kit: calculates the average result from up to 10 stored measured values, as well as min., max., n
- Tension loops and compression plates are included in delivery
- **2** Delivered in a robust carrying case

Technical data

- Transfer rate to PC: approx. 25 measured values per second
- Measuring precision: 0,5 % of [Max]
- Overload protection: 150 % of [Max]
- Overall dimensions W×D×H 45×25×0 mm
- Rechargeable battery pack integrated, as standard, operating time up to 40 h without backlight, charging time approx. 120 min
- External mains adapter, for connection to the USB-C connector, standard
- Cable length approx. 3 m
- Net weight approx. 1,6 kg

STANDARD



OPTION



Model	Measuring range [Max] kN	Readability [d] N	Price excl. of VAT ex works €	Option calibration certificate DAkkS accur. (≤ 5 kN)/Factory calibration certificate (> 5 kN)					
				Tensile Force		Compressive Force		Tensile/Compressive Force	
SAUTER			€	KERN	€	KERN	€	KERN	€
FH 1K	1	0,5	1000,-	963-162	235,-	963-262	235,-	963-362	440,-
FH 2K	2	1	1000,-	963-162	235,-	963-262	235,-	963-362	440,-
FH 5K	5	1	1270,-	963-163	330,-	963-263	330,-	963-363	580,-
FH 10K	10	5	1360,-	961-164	430,-	961-264	430,-	961-364	640,-
FH 20K	20	10	1370,-	961-164	430,-	961-264	430,-	961-364	640,-
FH 50K	50	10	1600,-	961-165	430,-	961-265	430,-	961-365	640,-
FH 100K	100	50	1680,-	961-166	475,-	961-266	475,-	961-366	700,-

Further calibration options on request



Discover more details and matching accessories online!

Universal digital force gauge with graphic-assisted display and integrated load cell

Features

- Turnable display with backlight
- Peak-Hold function to capture the peak value or Track function for continuous display of measurement
- Metal housing for durable use in harsh environmental conditions
- Can be mounted on all SAUTER test stands up to 5 kN
- Capacity display: A bar lights up to show how much of the measuring range is still available
- Measuring with tolerance range (limit-setting function): Upper and lower limit adjustable, in pull and push direction.

The process is supported by a visual signal

- Internal memory for up to 500 measurement values
- Continuous analogue output: Linear voltage signal in dependence to the load (-2 to +2V)
- USB data interface, as standard
- Selectable measuring units: N, kN, kgf, lbf
- 1 Standard attachments: as shown
- 2 Delivered in a robust carrying case

Technical data

- Transfer rate to PC: approx. 25 measured values per second
- Measuring precision: 0,2 % of [Max]
- Overload protection: 120 % of [Max]
- Overall dimensions W×D×H 215×75×30 mm
- Thread: M6
- Rechargeable battery pack integrated, as standard, operating time up to 10 h without backlight, charging time approx. 8 h
- Net weight approx. 0,55 kg

STANDARD



OPTION



Model	Measuring range [Max]	Readability [d]	Price excl. of VAT ex works €	Option Calibration certificate					
				Tensile Force		Compressive Force		Tensile/Compressive Force	
SAUTER	N	N	€	DAkkS accr. KERN	€	DAkkS accr. KERN	€	DAkkS accr. KERN	€
FL 5	5	0,002	570,-	-	-	-	-	-	-
FL 10	10	0,005	570,-	963-161	195,-	963-261	195,-	963-361	355,-
FL 20	25	0,01	570,-	963-161	195,-	963-261	195,-	963-361	355,-
FL 50	50	0,02	570,-	963-161	195,-	963-261	195,-	963-361	355,-
FL 100	100	0,05	570,-	963-161	195,-	963-261	195,-	963-361	355,-
FL 200	250	0,1	570,-	963-161	195,-	963-261	195,-	963-361	355,-
FL 500	500	0,2	570,-	963-161	195,-	963-261	195,-	963-361	355,-
FL 1K	1000	0,5	650,-	963-162	235,-	963-262	235,-	963-362	440,-

1 ONLY WHILE STOCKS LAST

Further calibration options on request



Discover more details and matching accessories online!

Powerful digital force gauge with graphic assisted display for tensile and compressive force measurements with external load cell

Features

- Premium force gauge with external measuring cell, tension loops included with delivery
- Turnable display with backlight
- Peak-Hold function to capture the peak value or Track function for continuous display of measurement
- Metal housing for durable use in harsh environmental conditions
- Can be mounted on all SAUTER test stands starting 1 kN
- Capacity display: A bar lights up to show how much of the measuring range is still available
- Measuring with tolerance range (limit-setting function): Upper and lower limit adjustable, in pull and push direction.
The process is supported by a visual signal

- Internal memory for up to 500 measurement values
- Continuous analogue output: Linear voltage signal in dependence to the load (-2 to +2V)
- USB data interface, as standard
- Selectable measuring units: N, kN, kgf, ozf, lbf
- **1** Delivered in a robust carrying case

Technical data

- Transfer rate to PC: approx. 25 measured values per second
- Measuring precision: 0,2 % of [Max]
- Overload protection: 120 % of [Max]
- Overall dimensions W×D×H 175×75×30 mm
- Dimensions load cell W×D×H
76,2×51×19 mm (FL 2K),
76,2×51×28 mm (FL 5K, 10K, 20K)
- Thread: M12
- Rechargeable battery pack integrated, as standard, operating time up to 10 h without backlight, charging time approx. 8 h
- Net weight approx. 1,4 kg

STANDARD



OPTION



Model	Measuring range [Max]	Readability [d]	Price excl. of VAT ex works €	Option calibration certificate DAkkS accr. (≤ 5 kN)/Factory calibration certificate (> 5 kN)					
				Tensile Force		Compressive Force		Tensile/Compressive Force	
SAUTER	N	N	€	KERN	€	KERN	€	KERN	€
FL 2K	2500	1	820,-	963-162	235,-	963-262	235,-	963-362	440,-
FL 5K	5000	2	890,-	963-163	330,-	963-263	330,-	963-363	580,-
FL 10K	10000	5	990,-	961-164	430,-	961-264	430,-	961-364	640,-
FL 20K	20000	10	990,-	961-164	430,-	961-264	430,-	961-364	640,-

1 ONLY WHILE STOCKS LAST
Further calibration options on request



Measurement of forces in different tensile or compression directions possible with only one measuring device



Supplied in a high-quality and robust system case (systainer® T-LOC) including plug-in power supply and USB cable type C

Premium force gauge with integrated load cell (optional) and connection possibility for up to 4 external load cells

Use with integrated load cell

The SAUTER FS premium force gauge has an load measuring cell for tensile and compressive force applications. Either mobile for rapid testing or stationary integrated into a test stand or production line, the multifunction display allows all the values recorded to be read off at a glance in real time. Via the integrated interface, the data can be sent to a PC or laptop for further processing.

Use with external load cells

The SAUTER FS premium force gauge is compatible with all SAUTER strain gauge measuring cells, see *Measuring Cells*. Up to 4 external measuring cells can be connected simultaneously.



Tip: Order the practical system case (systainer® T-LOC) for storing and transporting of accessories, clamps, sensors, etc. at the same time, SAUTER FS TKZ, see *Internet*



User-friendly touch pen for display included with the delivery



Simultaneous measurement on up to four channels. External sensors with sensor data memory, optionally available, see *Measuring Cells*



Compact force gauge with internal measuring cell (up to max. 500 N) for fast and mobile force measurements. Illustration shows optional accessories, SAUTER AE 500 screw tension clamp

Features

- 3,5" touchscreen with touch pen
- Standard version with 2 or 4 measuring channels for external force sensors (subsequently expandable from 2 to 4)
- An internal load cell is possible (is deactivated if an external load cell is connected)
- Suitable for 4-wire and 6-wire sensors with strain gauges
- Two-point adjustment with weights or numerical adjustment possible
- The specific data of an external sensor are stored directly in the connector
- USB interface for data transfer and power supply as standard
- Internal device memory (16 GB)
- Tolerance function
- Track function for continuous measurement display
- Peak value measurement

Technical data

- Resolution: up to 10000 points per measurement channel
- Storage of measured values as well as their transmission to the interface with up to 1000 Hz per measuring channel
- Measurement accuracy:
 - with internal load cell: 0.1 % of [Max]
 - with external load cell: among other things from the load cells used
- Overload protection: 150 % of [Max] with internal measuring cell
- Thread on load receptor: M6 (outer)
- Rechargeable battery pack integrated, as standard, operating time up to 8 h without backlight, charging time approx. 8 h
- External mains adapter, for connection to the USB-C connector, standard
- Overall dimensions W×D×H 71×31×180 mm
- Net weight approx. 0,40 kg

Optional calibration, see page 89

Calibration is recommended for each measuring cell!
 Assembly and adjustment of measuring cell, connector and sensors must be ordered separately, see table below, SAUTER FS 401 - FS 408

Discover more details and matching accessories online!

Order example SAUTER FS force gauge with 2 load cells:

1×	FS 2-500	2-channel force gauge with integrated load cell for tension/compression force measurements
1×	963-361	DAkkS-accredited calibration certificate tension/compression force up to 500 N
1×	CO 100-Y1	Miniature compression load cell up to 1 kN
1×	FS 403	Two-point adjustment up to 2 kN, incl. plug and memory for SAUTER FS
1×	963-262	DAkkS-accredited calibration certificate compression force up to 2 kN
1×	CS 500-3P2	Stainless steel "S" load cell for tension/compression force up to 5 kN
1×	963-363	DAkkS-accredited calibration certificate tension/compression force up to 5 kN
1×	FS 404	Two-point adjustment up to 5 kN, incl. connector and memory for SAUTER FS

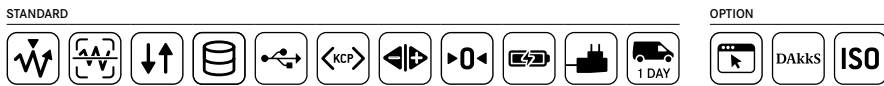

Service required for use with external sensors

Model	Measuring range internal load cell [Max] N	Readability internal load cell [d] N	Internal load cell	Number of measuring channels	Price excl. of VAT ex works €
SAUTER					
FS 2	-	-	-	2	950,-
FS 2-20	20	0,004	•	2	1070,-
FS 2-50	50	0,01	•	2	1070,-
FS 2-100	100	0,02	•	2	1070,-
FS 2-200	200	0,04	•	2	1070,-
FS 2-500	500	0,1	•	2	1070,-
FS 4	-	-	-	4	1070,-
FS 4-20	20	0,004	•	4	1180,-
FS 4-50	50	0,01	•	4	1180,-
FS 4-100	100	0,02	•	4	1180,-
FS 4-200	200	0,04	•	4	1180,-
FS 4-500	500	0,1	•	4	1180,-

Model	Adjustment of optional, external sensors	Measuring range [Max] kN	Price excl. of VAT ex works €
SAUTER			
FS 401	Numeric*	-	135,-
FS 402		0,5	160,-
FS 403		2	170,-
FS 404		5	195,-
FS 405	Two-point	20	205,-
FS 406		50	205,-
FS 407		120	225,-
FS 408		250	240,-

*only for sensors > 250 kN



Practical set of premium force gauge and measuring cell

Features

- Thanks to several versions, the pre-configured sets are suitable for tensile and compressive force measurements in a wide range of applications. The set includes the premium force gauge FS 2 and the necessary service FS 401 – FS 408
- It is supplemented optionally by:
 - FS SP1: 4-wire “S” measuring cell made of nickel-plated steel for force and mass measurement (CS P1). For tensile force and compressive force measurements, see larger picture
 - **1** FS RY1: Loadcell made of steel alloy (CR Y1). For tensile force and compressive force measurements
 - **2** FS RQ1: Load cell made of stainless steel (CR Q1). For compressive force measurements
 - **3** FS OY1: Miniature cylindrical load cell made from stainless steel (CO Y1). For compressive force measurements
 - **4** FS OY2: Miniature cylindrical load cell made from stainless steel (CO Y2). For tensile force and compressive force measurements

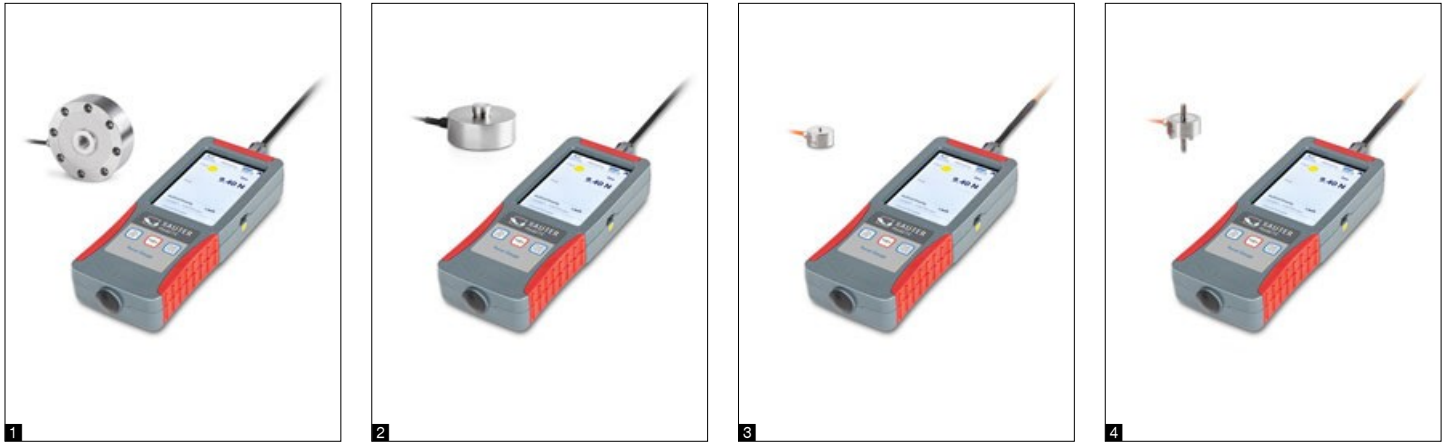

Discover more details and matching accessories online!

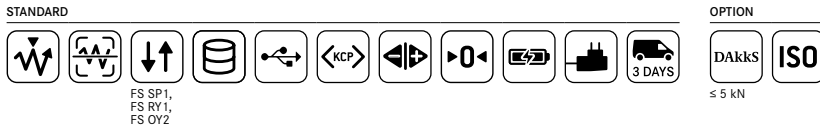

Modell	Measuring range [Max] N	Readout [d] N	Load cell in the set	Price excl. of VAT ex works €	Option calibration certificate DAKKS accr. (≤ 5 kN)/Factory calibration certificate					
					Tensile Force		Compressive Force		Tensile/Compressive Force	
SAUTER					KERN	€	KERN	€	KERN	€
1 FS SP1: For tensile force and compressive force measurements										
FS 2-1KSP1	1000	0,2	CS 100-3P1	1300,-	963-162	235,-	963-262	235,-	963-362	440,-
FS 2-2KSP1	2500	0,5	CS 250-3P1	1300,-	963-163	330,-	963-263	330,-	963-363	580,-
FS 2-5KSP1	5000	1	CS 500-3P1	1320,-	963-163	330,-	963-263	330,-	963-363	580,-
FS 2-10KSP1	10000	2	CS 1000-3P1	1390,-	961-164	430,-	961-264	430,-	961-364	640,-
FS 2-20KSP1	20000	4	CS 2000-3P1	1390,-	961-164	430,-	961-264	430,-	961-364	640,-
FS 2-50KSP1	50000	10	CS 5000-3P1	1410,-	961-165	430,-	961-265	430,-	961-365	640,-
FS 2-100KSP1	100000	20	CS 10000-3P1	1690,-	961-166	475,-	961-266	475,-	961-366	700,-
2 FS RY1: For tensile force and compressive force measurements										
FS 2-5KRY1	5000	1	CR 500-1Y1	1380,-	963-161	195,-	963-263	330,-	963-363	580,-
FS 2-50KRY1	50000	10	CR 5000-1Y1	1410,-	961-165	430,-	961-265	430,-	961-365	640,-
FS 2-100KRY1	100000	20	CR 10000-1Y1	1570,-	961-166	475,-	961-266	475,-	961-366	700,-
FS 2-200KRY1	200000	40	CR 20000-1Y1	1610,-	961-167	475,-	961-267	475,-	961-367	700,-
3 FS RQ1: For compressive force measurements										
FS 2-25KRQ1	25000	5	CR 2500-1Q1	1410,-	-	-	961-265	430,-	-	-
FS 2-50KRQ1	50000	10	CR 5000-1Q1	1410,-	-	-	961-265	430,-	-	-
FS 2-100KRQ1	100000	20	CR 10000-1Q1	1430,-	-	-	961-266	475,-	-	-
4 FS OY1: For compressive force measurements										
FS 2-500OY1	500	0,1	CO 50-Y1	1250,-	-	-	963-261	195,-	-	-
FS 2-2KOY1	2000	0,4	CO 200-Y1	1260,-	-	-	963-262	235,-	-	-
FS 2-5KOY1	5000	1	CO 500-Y1	1320,-	-	-	963-263	330,-	-	-
FS 2-20KOY1	20000	4	CO 2000-Y1	1350,-	-	-	961-264	430,-	-	-
4 FS OY2: For tensile force and compressive force measurements										
FS 2-100OY2	100	0,02	CO 10-Y2	1320,-	963-161	195,-	963-261	195,-	963-361	355,-
FS 2-500OY2	500	0,1	CO 50-Y2	1320,-	963-161	195,-	963-261	195,-	963-361	355,-
FS 2-1KOY2	1000	0,2	CO 100-Y2	1390,-	963-162	235,-	963-262	235,-	963-362	440,-



Fast testing of the stability of tombstones in accordance with VSG 4.7

SAUTER FA-G

- Pressure disc with foam rubber attachment
- Stainless steel handle with rubber covering for secure handling
- No electrical power supply required due to mechanical measuring system
- Real time or peak hold switch to observe transients or capture peaks by a drag indicator
- For tensile force and compressive force measurements
- Scope of delivery:
 - 1× FA 500
 - 1× AE 08
 - 1× AFH 04

SAUTER FL-G

- Ideal for the documented certification of specialist stone-cutter companies
- Rechargeable battery with long operating time (significantly more than 8 hours), so it is possible to use the device for a whole working day, in mobile mode
- Function to set limits: This is where you can program a stability limit value. If this limit value is exceeded, the device emits a visual signal. In this way, the measuring result does not need to be read off each time
- Wide pressure plate with foam rubber surface, so that the tombstone does not get scratched when force is applied
- Robust metal housing for permanent use under harsh environmental conditions
- Scope of delivery:
 - 1× FL 500/FL 1K
 - 1× AE 08
 - 1× AFH 04

SAUTER FS-G

- Through the internal and also external measuring cell it can also be used for more than just tombstone testing
- 3,5" touchscreen with touch pen
- USB interface for data transfer and power supply as standard
- Internal device memory (16 GB)
- Tolerance function
- Track function for continuous measurement display
- Peak value measurement
- Scope of delivery:
 - 1× FS 2-500
 - 1× AE 08
 - 1× AFK 02

Discover more details and matching accessories online!



STANDARD

OPTION

STANDARD

OPTION

STANDARD

OPTION

SAUTER	FA 500G	FL 500G	FL 1KG	FS 500G
Measuring range [Max] N	500	500	1000	500
Readout[d] N	2,5	0,2	0,5	0,1
Measuring precision of [Max]	1 %	0,2 %	0,2 %	0,1 %
Overload protection of [Max]	150 %	120 %	120 %	150 %
Price excl. of VAT ex works, €	355,-	690,-	810,-	1160,-
Option	Tensile Force	961-1610, € 195,-	961-161, € 195,-	961-162, € 235,-
Factory calibration certificate	Compressive Force	961-2610, € 205,-	961-261, € 195,-	961-262, € 235,-
	Tensile/Compressive force	961-3610, € 365,-	961-361, € 355,-	961-362, € 440,-
Option	Tensile Force	-	963-161, € 195,-	963-162, € 235,-
Calibration certificate	Compressive Force	-	963-261, € 195,-	963-262, € 235,-
DAkKS accr.	Tensile/Compressive force	-	963-361, € 355,-	963-362, € 440,-



Discover more details and matching accessories online!

Compact force measuring instrument

Features

- Checking the consistency of sprayed concrete is essential to ensure the maximum strength of the concrete during the curing process
- The FC 1K-BT determines exactly the forces required for the needle to penetrate the concrete. This allows reliable conclusions to be made regarding the compressive strength of the concrete during the dry phase
- Peak-Hold function to capture the peak value or Track function for continuous display of measurement
- Metal housing for durable use in harsh environmental conditions

- Capacity display: A bar lights up to show how much of the measuring range is still available
- Limit value function, programming of Max./Min., with output of acoustic and optical signal per ok indication
- Safety: If loads exceed 110 % of the measuring range, the device will give clear acoustic and visual signals
- Internal memory for up to 500 measurement values
- Turnable display with backlight
- Selectable: AUTO-OFF function or continuous operation, charge indicator
- **1** Delivered in a robust carrying case

Technical data

- Transmission rate to PC: up to 200 measured values/second
- Measuring precision: 0,3 % of [Max]
- Overload protection: 150 % of [Max]
- Housing dimensions W×D×H 145×73×34 mm
- Net weight approx. 1,8 kg
- Selectable measuring units: N, kgf, ozf, lbf
- Robust, cleanable and portable construction
 - Built-in 1000 N force measuring cell
 - Rapid and simple changing of the penetration needle
 - Inverted display for better readability
 - Live peak force value for immediate monitoring
 - Measurement precision ± 0,1 %
 - USB interface
- **2** Penetration needle and adapter
 - Removable if necessary
 - Needle diameter: 3 mm
 - Upper angle: 60 degrees
 - Length: 15 mm
 - Included: 15 needles

STANDARD



OPTION



Model	Measuring range [Max] N	Readability [d] N	Price excl. of VAT ex works €	Option Calibration certificate			
				Tensile Force		Compressive Force	
SAUTER				DAkkS accr. KERN	€	DAkkS accr. KERN	€
FC 1K-BT	1000	1	1320,-	963-162	235,-	963-262	235,-

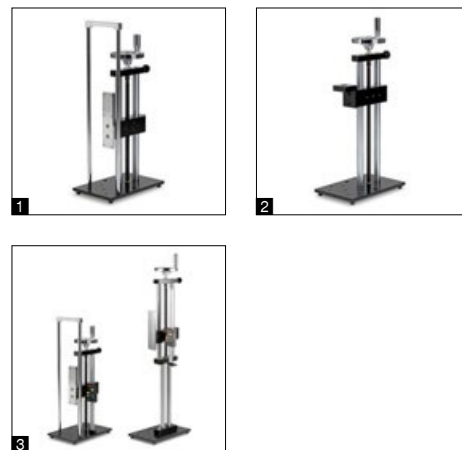

Discover more details and matching accessories online!

Manual test stand for highly accurate tensile and compressive force measurements

Features

- For vertical and horizontal use
- Precise measurement results
- High level of security at repeated measurements
- Large base plate with high versatility of fastening objects
- SAUTER TVL, TVL-XLS: Digital length meter SAUTER LA (without interface) as standard
 - Measuring range: max. 200 mm
 - Readability: 0,01 mm
 - Zero setting possible
 - Pre-length can be set manually
- **1** SAUTER TVL-O: Manual test bench without SAUTER LA length measuring device
- **2** SAUTER TVL-E: Test bench for force-measuring devices with an external measuring cell

- SAUTER TVL-O, TVL-E:
 - As an option, the SAUTER LB length measuring device (with interface) can be fitted, see internet
- SAUTER TVL, TVL-XLS, TVL-O: Suitable for all SAUTER force measuring devices with internal measuring cell up to 1000 N (not included in delivery)
- SAUTER TVL-E: Suitable for all SAUTER force measuring devices with external measuring cell up to 2000 N (not included in delivery)
- SAUTER TVL: Hook with M6 thread as standard
- SAUTER TVL-XLS: consisting of: SAUTER TVL + SAUTER TVL-XL, see internet
- **3** Model TVL and TVL-XLS in size comparison

Technical data

- Base plate with threaded hole M6
- Travel distance per knob rotation (stroke per one turn):
 - SAUTER TVL-XLS, TVL, TVL-O: 3 mm
 - SAUTER TVL-E: 2 mm

Save with our practical bundles of test stand, force gauge and matching clamps, e.g. SAUTER TVL 500FHS71, consisting of:

- 1x TVL
- 1x FH 500 (Details see page 12)
- 2x AE 500

You can find our bundles on page 24

STANDARD



TVL, TVL-XLS

Model	Measuring range [Max] N	Maximum travel distance mm	Length measuring device at delivery	Dimensions WxDxH mm	Net weight approx. kg	Price excl. of VAT ex works €
SAUTER TVL-XLS	500	230	Length measuring device with display	200x300x800	12	760,-
TVL	1000	230		151x234x465	9	450,-
TVL-O	1000	230	Length measuring device with display and data	151x234x465	9	290,-
TVL-E	2000	290	interface (optional)	154x240x550	8	610,-



SAUTER TVP



SAUTER TVP-L

Discover more details and matching accessories online!

Manual test stands for compressive force measurements, also with digital length measurement

Features

- Provides quick and consistent testing
- High level of security at repeated measurements
- Provides maximum versatility and precise measuring results
- Slide construction for distance measurement
- Large base plate with high versatility of fastening objects
- Suitable for all SAUTER force gauges up to 500 N (not included in delivery)
- SAUTER TVP-L: Digital length meter
 - Measuring range: 100 mm
 - Readability: 0,01 mm
 - Zero setting possible
 - Pre-length can be set manually
 - without interface

Technical data

- Maximum work zone: 315 mm
- Maximum stroke length: 78 mm
- Base plate with threaded hole M6
- Overall dimensions W×D×H 150×233×420 mm
- Net weight approx. 11 kg

STANDARD



TVP-L

Model	Measuring range	Price excl. of VAT ex works €
SAUTER TVP	[Max] N 500	305,-
SAUTER TVP-L	500	445,-



Discover more details and matching accessories online!

The practical all-in-one package for rapid, simple testing

FH 500S71

- All-in-One: Digital force-measuring device incl. clamp
- For rapid, simple testing of forces up to 500 N
- Assembly and configuration of the parts is not required and therefore saves time and effort
- For tensile force and compressive force measurements

TVL 500FHS71

- All-in-One: test stand with digital force-measuring device and 2 clamps
- For manual testing with a pitch of 3 mm/rotation and for forces up to 500 N
- Assembly and configuration of the parts is not required and therefore saves time and effort
- For tensile force and compressive force measurements

STANDARD



OPTION



Model	Measuring range [Max] N	Division [d] N	Scope of delivery	Price excl. of VAT ex works €	Option Calibration certificate					
					Tensile Force		Compressive Force		Tensile/Compressive Force	
SAUTER					DAkkS-accr. KERN	€	DAkkS-accr. KERN	€	DAkkS-accr. KERN	€
FH 500S71	500	0,1	1× FH 500 1× AE 500	710,-	963-161	195,-	963-261	195,-	963-361	355,-
TVL 500FHS71	500	0,1	1× TVL 1× FH 500 2× AE 500	1380,-	963-161	195,-	963-261	195,-	963-361	355,-



1

Discover more details and matching accessories online!

Robust premium test stand for laboratory applications

Features

- Motorised test stand for tension/compression force measurements
- Table-top design for comfortable operation
- Robust design for durable use
- Easy-to-access safety switch-off
- Upper and lower end point of the traverse distance can be set individually
- Automatic or manual operation mode
-  Suitable for all SAUTER force gauges up to 500 N, e.g. SAUTER FH-S, for details see page 12 (not included in delivery)

Technical data

- Maximum tensile and compressive force: 500 N
- Speed accuracy: 2 % of [Max]
- Overall dimensions W×D×H 570×428×236 mm
- Net weight approx. 28 kg

STANDARD



OPTION



Model	Measuring range	Speed range	Maximum travel distance	Price excl. of VAT ex works €
SAUTER	[Max] N	mm/min	mm	
TVO 500N300	500	15 - 300	270	2350,-



Premium test stand in table-top version – with precise step motor – also available as a set



Solid and flexible fixing options for many clamps and accessories from the SAUTER product range, see internet



A wide range of application possibilities because of its large travelling distance



Interface for data transmission from the SAUTER FH measuring device and for controlling the test stand with SAUTER AFH software

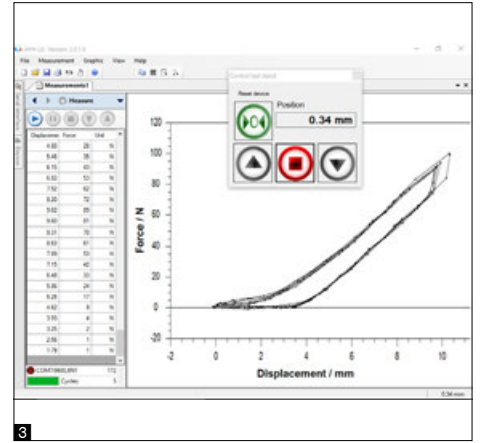

Features

- Motorised test stand for tension/compression force measurements. **1** Also available as a practical set TVO-LD for force-displacement-measurements in laboratory and industry
- Stepper motor for greatest ease of use
 - for constant speed from the smallest to the maximum load
 - allows testing at minimum speed and full load
 - for higher positioning accuracy.
- Precise starting and stopping, without overrun, even at high speeds
- precise adjustment of the displacement speed using the information shown on the display
- Automatic or manual operation mode
- **2** Premium operating panel:
 - Digital speed display
 - Digital repeat function display
 - Control of the test stand using PC software SAUTER AFH **3**
- Table-top design for comfortable operation
- Robust construction
- Fixation of SAUTER force measuring devices up to 2 kN possible

1 SAUTER TVO-LD

- Five in one – motorised test stand, length measuring system LD, interface cable, data transfer software AFH LD, interface converter AFH 12 and mounting
- With linear potentiometer for length measurement to create force-displacement diagrams on PC, maximum measuring range 300 mm / 500 mm / 700 mm, readability 0,01 mm, measuring accuracy 0.5 % of [Max], USB-A cable 1,5 m, high data acquisition speed

Technical data

- Speed accuracy: 0,5 % of [Max]
- Positioning accuracy when shutting down: ± 0,05 mm

Discover more details and matching accessories online!

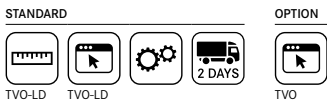

Model	Measuring range	Speed range	Maximum travel distance	Price excl. of VAT ex works €
	[Max] N	[Max] mm/min	mm	
SAUTER				
TVO 500N500S	500	1 - 500	270	3780,-
TVO 1000N500S	1000	1 - 500	500	3900,-
TVO 2000N500S	2000	1 - 500	700	5550,-
Sets incl. test stand, length measuring system, interface cable, software AFH LD, assembly:				
TVO 500N500S-LD	500	1 - 500	270	5050,-
TVO 1000N500S-LD	1000	1 - 500	500	5250,-
TVO 2000N500S-LD	2000	1 - 500	700	6980,-



Motorised test stand incl. length measuring device LB

Test stand with electric motor for standard measurements – also available as a set



Premium operating panel
 - Digital speed display
 - Digital repeat function

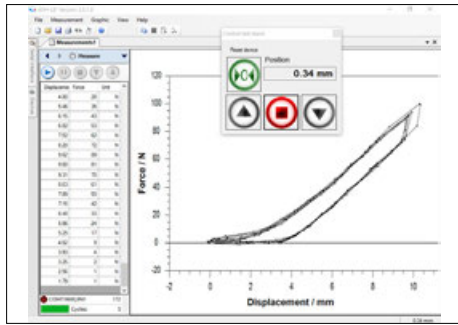

Control of the test stand using PC software SAUTER AFH



Solid and flexible fixing options of a wide range of clamps and accessories from the SAUTER range, see internet

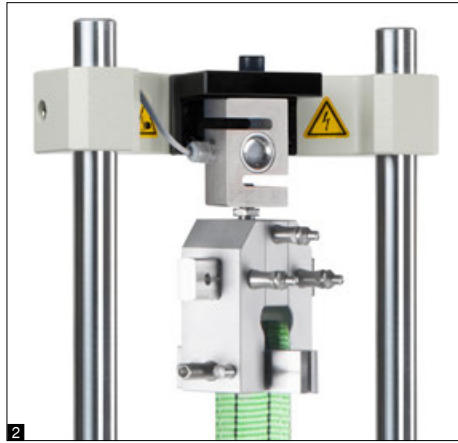

Features

- Motorised test stand for tension/compression force measurements. Also available as a practical set for force-displacement-measurements in laboratory and industry
- Force controlled automatic switchoff, teststop after achieving an adjusted limit load, only in connection with a SAUTER FH force gauge
- Maximum displacement protected by electronic end switches
- Particularly flexible mounting options for variable force SAUTER measuring devices, such as, FC, FH, FK, FL
 - **1** Direct mounting of measuring devices with internal load cell up to a measuring range of 500 N (only for TVM 5000N230N)
 - **2** Direct mounting of the external load cell on the traverse, starting with 1000 N measurement range and higher
 - Option: **3** Holder for force measuring devices of the SAUTER FH range with external load cell, see internet

SAUTER TVM-N/TVM-NL

- SAUTER LA length measuring device as standard, to read the travel distance with a readability of 0,01 mm

SAUTER TVM-LB

- Five in one – motorised test stand, digital length measuring device LB, interface cable, data transfer software AFH FD, two interface converters AFH 12 and mounting
- With digital length measuring device LB for creating force-displacement diagrams on the PC, maximum measuring range 300 mm, readability 0,01 mm

Discover more details and matching accessories online!

Technical data

- Maximum travel distance: 210 mm
- Speed accuracy: 3 % of [Max]

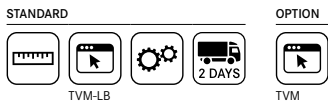

Model	Measuring range [Max] N	Speed range [Max] mm/min	Length of columns mm	Price excl. of VAT ex works €
SAUTER				
TVM 5000N230N	5000	10 - 230	635	2650,-
TVM 5000N230NL	5000	10 - 230	1135	3120,-
TVM 10KN120N	10000	30 - 120	1135	3650,-
TVM 20KN120N	20000	30 - 120	1135	4900,-
Sets incl. test stand, length measuring device, interface cable, software AFH FD, assembly:				
TVM 5000N230N-LB*	5000	10 - 230	635	4830,-
TVM 5000N230NL-LB*	5000	10 - 230	1135	5310,-
TVM 10KN120N-LB*	10000	30 - 120	1135	5800,-
TVM 20KN120N-LB*	20000	30 - 120	1135	6990,-

1 * ONLY WHILE STOCKS LAST



Motorised test stand incl. length measuring system LD

Premium test stand with step motor for precise testing up to 50 kN – also available as a set



Premium operating panel
 - Digital speed display for a direct reading of the displacement speed
 - Digital repeat function for long-term stress test

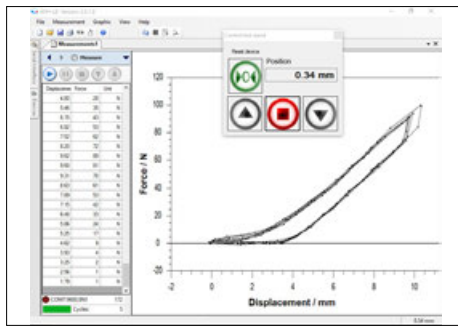

Control of the test stand using PC software SAUTER AFH



Solid and flexible fixing options for many clamps and accessories from the SAUTER product range, see internet

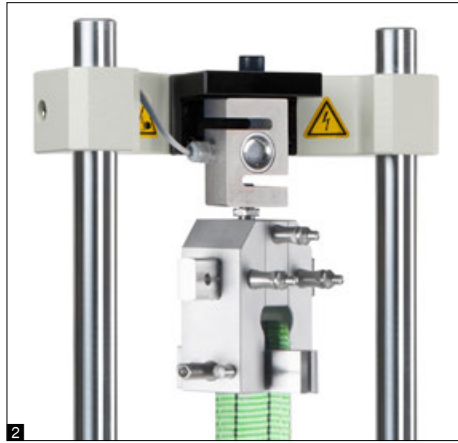

Features

- Motorised test stand for tension/compression force measurements. Also available as a practical set TVS-LD for force-displacement-measurements in laboratory and industry
- Stepper motor for greatest ease of use
 - for constant speed from the smallest to the maximum load
 - allows testing at minimum speed and full load
 - for higher positioning accuracy. Precise starting and stopping, without overrun, even at high speeds
 - precise adjustment of the displacement speed using the information shown on the display
- Maximum displacement protected by electronic end switches
- Large working area by means of long guide columns as standard, which allows a wide range of fixing options
- Particularly flexible mounting options for variable force measuring devices, such as, for example, SAUTER FC, FH, FK, FL:
 - ❶ Direct mounting of measuring devices with internal load cell up to a measuring range of 500 N (only for TVS 5000N240)
 - ❷ Direct mounting of the external load cell on the traverse, starting with 1000 N measurement range and higher
 - ❸ Option: Holder for force measuring devices of the SAUTER FH range with external load cell, see internet
- Only TVS: SAUTER LA length measuring device as standard, to read the travel distance with a readability of 0,01 mm

SAUTER TVS-LD

- Five in one – premium motorised test stand, length measuring system LD, interface cable, data transfer software AFH LD, interface converter AFH 12 and mounting
- With linear potentiometer for length measurement to create force-displacement diagrams on PC, maximum measuring range 300 mm, readability 0,01 mm, measuring accuracy 0.5 % of [Max], USB-A cable 1,5 m, high data acquisition speed

Technical data

- Maximum travel distance: 210 mm
- Speed accuracy: 1 % of [Max]
- Positioning accuracy when shutting down: ± 0,05 mm

Discover more details and matching accessories online!

STANDARD OPTION

TVS-LD

2 DAYS

TVS

Model	Measuring range [Max] N	Speed range [Max] mm/min	Length of columns mm	Price excl. of VAT ex works €
SAUTER				
TVS 5000N240	5000	1 - 240	1135	5450,-
TVS 10KN100	10000	1 - 200	1135	6900,-
TVS 20KN100	20000	1 - 100	1135	7000,-
TVS 50KN80	50000	1 - 70	1135	9900,-
Sets incl. test stand, length measuring system, interface cable, software AFH LD, assembly:				
TVS 5000N240-LD	5000	1 - 240	1135	6490,-
TVS 10KN100-LD	10000	1 - 200	1135	7990,-
TVS 20KN100-LD	20000	1 - 100	1135	8090,-
TVS 50KN80-LD	50000	1 - 70	1135	10990,-



NEW



Discover more details and matching accessories online!

Manual test stand with innovative quick adjustment for applications up to 7 kN

Features

- **1** Manual test stand with integrated quick adjustment of the upper crosshead for particularly easy height adjustment when changing test specimens
- Maximum force up to 7 kN
- Suitable for all SAUTER force gauges
- For vertical and horizontal use
- Readable scale with zero setting function for convenient reading of the length value
- Large base plate with high versatility of fastening objects
- Easily expandable or modifiable thanks to modular system

Technical data

- Base plate with threaded hole M 12
- Travel distance per knob rotation (stroke per one turn): 0,8 mm
- Total spindle stroke: 100 mm
- Overall dimensions W×D×H 480×530×1060 mm
- Net weight approx. 28 kg

Main scope of applications

- Automotive industry
- Electrical engineering and electronics
- Plastics and rubber industry
- Metal processing
- Packaging industry
- Research and development / test laboratories
- Quality assurance / incoming goods inspection

STANDARD



Model

Measuring range

Price
excl. of VAT
ex works
€

SAUTER

[Max]
N

TVQ



7000

2590,-

FASTENERS & ACCESSORIES

It is often the little details that make a crucial difference. Fasteners such as clamps and brackets are small but essential connecting elements between measuring devices and test benches or workpieces. Precise and reproducible measurements would not be possible without them.

In addition to a wide selection of fasteners, SAUTER also offers suitable accessories to provide you with the ideal support for your measurements. Whether standard or customised solutions, our range has everything you need for precise and efficient measuring.

Our experts are at your side with their specialised knowledge to help you select the best components for your measuring systems.



We will be happy to advise you:
Tel. +49 7433 9933-562
info.sauter@kern-sohn.com

Accessories

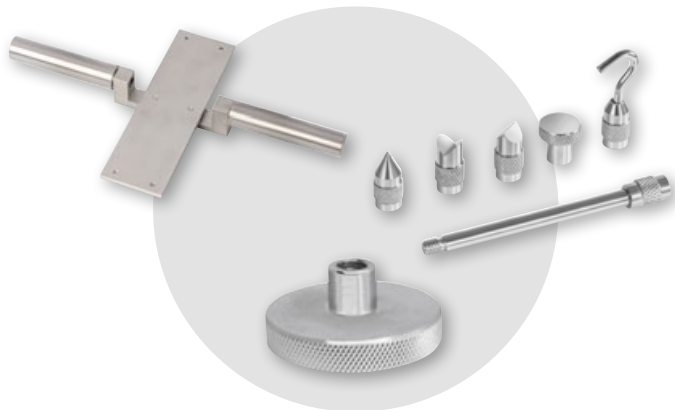

Jaws

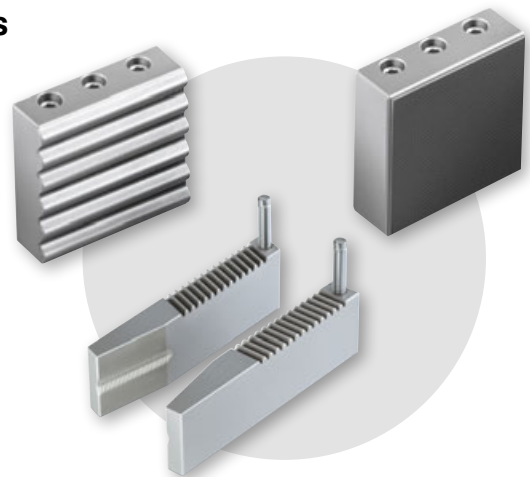

Clamps

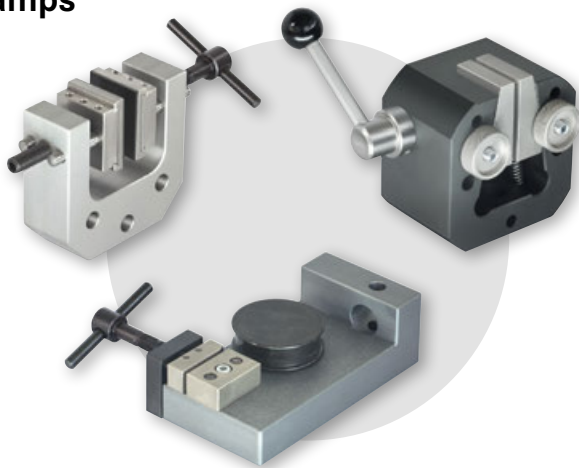

Connection adapters



You can find the full range of clamps & brackets as well as the entire assortment of accessories with many other parts on our website www.kern-sohn.com

Or you can simply scan the code for detailed information, technical data and prices.



INDIVIDUAL CUSTOMIZED SOLUTIONS DESIGNED TO YOUR REQUIREMENTS

You haven't found a matching clamping solution in our assortment?

No problem, we will develop the matching clamping system that is tailored to your test system. With innovative solutions and many years of experience, we provide your team or company with technological support and jointly develop the suitable clamping system.

CUSOS – perfectly tailored to you and your requirements

The development of your customised clamping system is carried out using the latest technologies. From the idea, during the development, the manufacturing process, to the finished product, we and our partners use the latest and most modern techniques.

Contact us today and ask for your individual solution.



CUSTOMIZED
SOLUTION SERVICE



Enrico Steier
Product Manager SAUTER
Force Measurement
Tel. +49 7433 9933-194
enrico.steier@kern-sohn.com

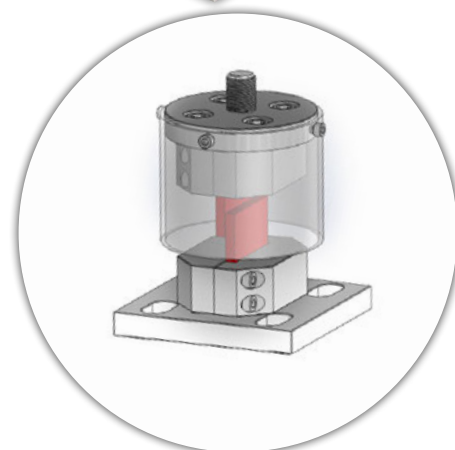
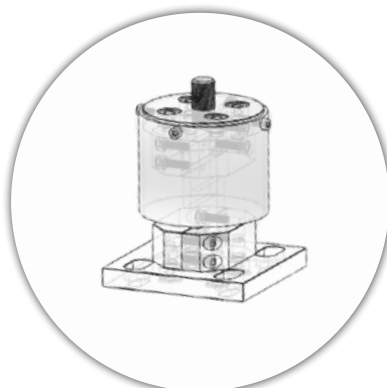
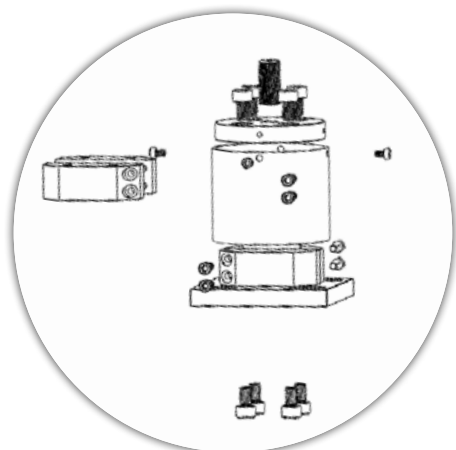
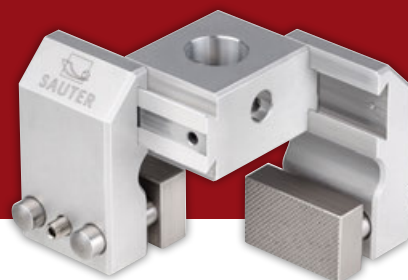

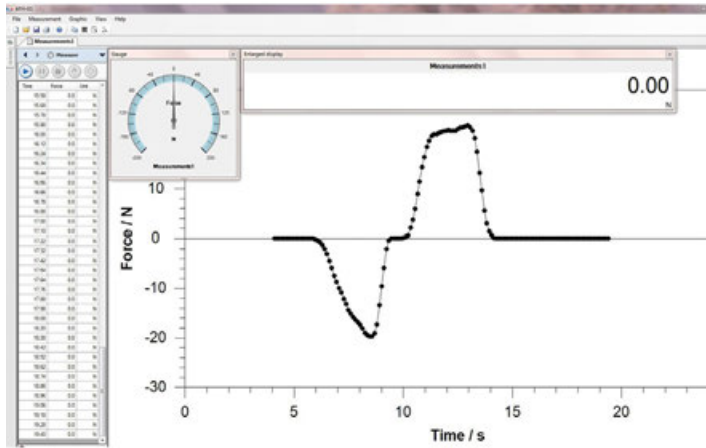

1	2	3	4	5	6	7	8	9	10	11	12	13	14	15	16	17	18	19	20
1	4.12000000	0	N	FH 200	NAN	NAN	2013-11-08T11:51:26.000000000	0.0											
2	4.21000000	0	N	FH 200	NAN	NAN	2013-11-08T11:51:26.000000000	0.0											
3	4.31000000	0	N	FH 200	NAN	NAN	2013-11-08T11:51:26.000000000	0.0											
4	4.41000000	0	N	FH 200	NAN	NAN	2013-11-08T11:51:26.000000000	0.0											
5	4.51000000	0	N	FH 200	NAN	NAN	2013-11-08T11:51:26.000000000	0.0											
6	4.61000000	0	N	FH 200	NAN	NAN	2013-11-08T11:51:26.000000000	0.0											
7	4.71000000	0	N	FH 200	NAN	NAN	2013-11-08T11:51:26.000000000	0.0											
8	4.81000000	0	N	FH 200	NAN	NAN	2013-11-08T11:51:26.000000000	0.0											
9	4.91000000	0	N	FH 200	NAN	NAN	2013-11-08T11:51:26.000000000	0.0											
10	5.01000000	0	N	FH 200	NAN	NAN	2013-11-08T11:51:26.000000000	0.0											
11	5.11000000	0	N	FH 200	NAN	NAN	2013-11-08T11:51:26.000000000	0.0											
12	5.21000000	0	N	FH 200	NAN	NAN	2013-11-08T11:51:26.000000000	0.0											
13	5.31000000	0	N	FH 200	NAN	NAN	2013-11-08T11:51:26.000000000	0.0											
14	5.41000000	0	N	FH 200	NAN	NAN	2013-11-08T11:51:26.000000000	0.0											
15	5.51000000	0	N	FH 200	NAN	NAN	2013-11-08T11:51:26.000000000	0.0											
16	5.61000000	0	N	FH 200	NAN	NAN	2013-11-08T11:51:26.000000000	0.0											
17	5.71000000	0	N	FH 200	NAN	NAN	2013-11-08T11:51:26.000000000	0.0											
18	5.81000000	0	N	FH 200	NAN	NAN	2013-11-08T11:51:26.000000000	0.0											
19	5.91000000	0	N	FH 200	NAN	NAN	2013-11-08T11:51:26.000000000	0.0											

Discover more details and matching accessories online!

Data transfer software for force-time-measurements

Features

- Force measurements can be conducted over a very short period, i.e. seconds
- A high speed data transfer to a PC is possible (with a transfer of up to 20 data sets per second) when combining the AFH FAST with SAUTER FH, FC or FL
- AFH FAST shows the results in a Force-Time-Graph and can export the data to Microsoft Excel®
- Compatible with the following operating system: Microsoft Windows® 10, 11

Technical data

- Data recording rate approx. 20 measurements per second with SAUTER FH, FC, FL, DA and DB

STANDARD



Model	Price excl. of VAT ex works €
SAUTER AFH FAST	115,-

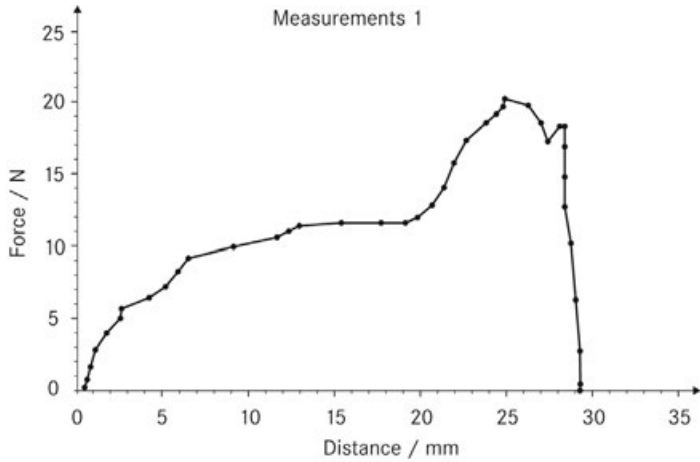

Discover more details and matching accessories online!

Data transfer software for force-displacement-measurements

Features

- AFH LD software is designed for all applications that require the measurement of forces, depending on the displacement. Typically these are force progression graphs in penetration tests or pullout tests
- The program simultaneously requests the measurements from a force measuring device, e.g. SAUTER FH, as well as a length measuring device, SAUTER LD 1, 2
- The measurements from both instruments are transferred continuously to the PC, synchronised by the AFH LD software and exported in the form of a graphic, as well as free data format for simple processing in Microsoft Excel®
- The software AFH LD is compatible with all instruments of series SAUTER FC, FH, FL, FS
- The SAUTER LD length measuring device is compatible with the SAUTER TVO and TVS motorised test benches

Further analysis functions:

- Extension of the test object
- Tensile and compressive force
- Endurance testing
- Archiving the recorded data

Scope of delivery:

- Software AFH LD as download
- User manual

- Compatible with the following operating system: Microsoft Windows® 10, 11

SAUTER AFH LD

- Force-displacement software, but only in combination with a length measuring device of SAUTER LD series

Technical data

- Data recording rate max. 25 Hz (in combination with SAUTER LD, dependent on measuring instrument)

STANDARD



Model	Price excl. of VAT ex works €
SAUTER	
AFH LD	270,-

No.	Messwert	Einheit	Richtung	Material	Datum	Zeit
6	182	HL	0	Stee&Cast Steel	11. Nov	21:00
7	408	HL	0	Stee&Cast Steel	11. Nov	21:00
8	343	HL	0	Stee&Cast Steel	11. Nov	21:00
9	343	HL	0	Stee&Cast Steel	11. Nov	21:00
10	400	HL	0	Stee&Cast Steel	11. Nov	21:00
11	429	HL	0	Stee&Cast Steel	11. Nov	21:00
12	400	HL	0	Stee&Cast Steel	11. Nov	21:00
13	397	HL	0	Stee&Cast Steel	11. Nov	21:00
14	447	HL	0	Stee&Cast Steel	11. Nov	21:00
15	396	HL	0	Stee&Cast Steel	11. Nov	21:00
16	395	HL	0	Stee&Cast Steel	11. Nov	21:00
17	429	HL	0	Stee&Cast Steel	11. Nov	21:00
18	395	HL	0	Stee&Cast Steel	11. Nov	21:00
19	399	HL	0	Stee&Cast Steel	11. Nov	21:00
20	398	HL	0	Stee&Cast Steel	11. Nov	21:00
21	403	HL	0	Stee&Cast Steel	11. Nov	21:00
22	392	HL	0	Stee&Cast Steel	11. Nov	21:00
23	390	HL	0	Stee&Cast Steel	11. Nov	21:00
24	403	HL	0	Stee&Cast Steel	11. Nov	21:00
25	393	HL	0	Stee&Cast Steel	11. Nov	21:00

Discover more details and matching accessories online!

Plug-In for data transfer of measuring data from the measuring instrument and transfer to a PC, e.g. in Microsoft Excel®

Features

- Ideal for transferring measuring data from the internal data memory of the measuring instrument to Microsoft Excel®
- Solution: SAUTER AFI-2.0 plug-in for Microsoft Excel®. By doing this, an installation and learning yet another software can be avoided
- Compatible with Microsoft Excel® 2013 et seq.
- Easy handling: The measuring instrument is connected to the PC. At the push of a button, the SAUTER AFI-2.0 plug-in scans all the existing serial interfaces on the PC, finds the relevant measuring instrument and then reads the measuring data memory

Technical data

- Suitable for the following ranges:
SAUTER FL, FS, DA, DB, HN-D, HK-D, HK-DB, SW

STANDARD



2



TORQUE MEASUREMENT

There is a fundamental differentiation here between the measurement of static and dynamic torques.

Dynamic torques measurement is typically carried out using torque sensors on test objects which are rotating – during the movement.

Static torques measurement, on the other hand, is always carried out when the item is at rest.

The SAUTER range includes static torques gauges for determining the torque expended when opening rotary or screw caps of any kind.

Further typical applications of static torque measuring devices are testing of assembly tools for screws and nuts, in particular torque keys and mechanical assembly tools such as cordless electric screw drivers.



Helga Biselli
Product Specialist
Torque Measurement
Tel. +49 7433 9933-188
info@sauter.eu

Quick-Finder

Readout	Measuring range	Model	Price excl. of VAT	Page
[d] Nm	[Max] Nm	SAUTER	ex works €	
0,0001	0,5	DB 0.5-4	1750,-	40
0,0002	1	DA 1-4	1960,-	39
0,0002	1	DB 1-4	1750,-	40
0,001	5	DA 5-3	1960,-	39
0,001	5	DB 5-3	1750,-	40
0,002	10	DA 10-3	1950,-	39
0,002	10	DB 10-3	1750,-	40
0,005	20	DB 20-3	1990,-	40
0,01	50	DB 50-2	1990,-	40
0,02	100	DB 100-2	1990,-	40
0,05	200	DB 200-2	1990,-	40
0,1	500	DB 500-2	1990,-	40



2

Discover more details and matching accessories online!

Comfortable testing of screw tops, e.g. bottles, jars etc.

Features

- **1** Optimised for torque testing of bottles, jars and other packaging with screw tops with a minimum diameter of 15 mm and a maximum diameter of 160 mm, in the food industry and pharmaceutical industry, as well as in the manufacturing of cosmetics such as, for example, lipsticks, etc.
- **2** Quick pin system: The four bottle mounts (holders) are pushed in, instead of being screwed in, to save time. This allows you to reconfigure quickly for other bottle sizes
- Metal housing for durable use in harsh environmental conditions
- **3** Capacity display: A bar lights up to show how much of the measuring range is still available
- **3** LCD graphics display with backlight

- Rubber feet with anti-slip feature
- Internal data memory saves up to 500 measurements. The memory contents can be transferred to the PC using optional software
- **4** Data interface USB and RS-232 included
- Peak-Hold function to capture the peak value or Track function for continuous display of measurement
- Can be used in both directions of rotation
- Measuring with tolerance range (limit-setting function): Upper and lower limiting can be programmed individually. The process is supported by an audible and visual signal
- AUTO-OFF function
- Scope of delivery: four bottle holders with rubber coating, sturdy carrying case

Technical data

- Selectable measuring units: Nm, kgf/cm, kgf/m, in/lbs, ft/lbs
- Measuring precision: $\pm 0,5\%$ of [Max]
- Usable measuring range: 5 - 100 % of [Max]
- Overload protection: 120 % of [Max]
- Rechargeable battery pack integrated, as standard, operating time up to 18 h without backlight, charging time approx. 14 h
- Overall dimensions WxDxH 260x160x60 mm
- Net weight approx. 3,0 kg

STANDARD



OPTION



Model	Measuring range	Readout	Diameter test object	Price excl. of VAT ex works €	Option	
					Factory calibration certificate	
SAUTER	[Max] Nm	[d] Nm	mm		KERN	€
DA 1-4	1	0,0002	160	1960,-	961-120	245,-
DA 5-3	5	0,001	160	1960,-	961-120	245,-
DA 10-3	10	0,002	160	1950,-	961-120	245,-



Discover more details and matching accessories online!

Convenient way to test the torque of tools

Features

- **1** Particularly suitable for testing torque wrenches, electric hand screwdrivers and cordless screwdrivers
- **2** Screw joint simulator for dynamic testing of electric screwdrivers (from SAUTER DB 0.5-4 to DB 50-2)
- Metal housing for durable use in harsh environmental conditions
- Capacity display: A bar lights up to show how much of the measuring range is still available
- LCD graphics display with backlight
- Rubber feet with anti-slip feature (from SAUTER DB 0.5-4 to DB 10-3)
- **3** Stable mounting plate for solid fixation (from SAUTER DB 20-3 to DB 500-2)
- Data interface USB and RS-232 included

- Internal data memory saves up to 500 measurements. The memory contents can be transferred to the PC using optional software
- Peak-Hold function to capture the peak value or Track function for continuous display of measurement
- Can be used in both directions of rotation
- Measuring with tolerance range (limit-setting function): Upper and lower limiting can be programmed individually. The process is supported by an audible and visual signal
- AUTO-OFF function
- Scope of delivery: Torque pick-up, sturdy carry case, mounting plate (for models with [Max] ≥ 20 Nm)

Technical data

- Backlit LCD graphics display
- Selectable measuring units: Nm, kgf/cm, kgf/m, in/lbs, ft/lbs
- Measuring precision: ± 0,5 % of [Max]
- Usable measuring range: 5 - 100 % of [Max]
- Overload protection: 120 % of [Max]
- Rechargeable battery pack integrated, as standard, operating time up to 18 h without backlight, charging time approx. 14 h
- Overall dimensions W×D×H 180×110×60 mm
- Net weight approx. 2,2 kg



Model	Measuring range [Max] Nm	Readout [d] Nm	Tool fitting mm/Inch	Price excl. of VAT ex works €	Option	
					Factory calibration certificate	
SAUTER					KERN	€
DB 0.5-4	0,5	0,0001	20 mm & 3/8"	1750,-	961-120	245,-
DB 1-4	1	0,0002	20 mm & 3/8"	1750,-	961-120	245,-
DB 5-3	5	0,001	20 mm & 3/8"	1750,-	961-120	245,-
DB 10-3	10	0,002	20 mm & 3/8"	1750,-	961-120	245,-
DB 20-3	20	0,005	20 mm & 3/8"	1990,-	961-120	245,-
DB 50-2	50	0,01	20 mm & 3/8"	1990,-	961-120	245,-
DB 100-2	100	0,02	3/8"	1990,-	961-120	245,-
DB 200-2	200	0,05	1/2"	1990,-	961-120	245,-
DB 500-2	500	0,1	3/4"	1990,-	961-120	245,-

3



COATING THICKNESS MEASUREMENT

Measurement of coating thicknesses is known from, for example, the paint measurement for coating thickness at cars. In fact, these measurements are used much more widely in industrial applications. This is where the thickness of the surface finish is measured, such as galvanisation, zinc coating etc. or also lacquers.

Fundamentally there are two measuring principles for determining coating thickness:



Typ F: Non-magnetic coatings on magnetic metals, such as iron or steel (magnetic induction principle). Here are some sample material combinations:

- 1) [chrome, copper, rubber, lacquer] on
- 2) [steel, iron, alloys, magnetic stainless steel]



Typ N: Coatings on non-magnetic metals, such as aluminium (eddy current principle). Here are some sample material combinations:

- 3) [lacquer, paints, enamel, chrome, plastics] on
- 4) [aluminium, brass, sheet metal, copper, zinc, bronze]



Irmgard Russo
Product Specialist
Coating Thickness Measurement
Tel. +49 7433 9933-208
info@sauter.eu



Typ FN: All coatings as for type F and N on all metals as for type F and N (combination of magnetic induction and eddy current principle)

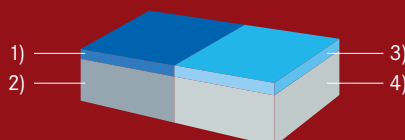

Quick-Finder

Readout	Measuring range	Model	Price excl. of VAT	Page
[d] µm	[Max] µm	SAUTER	ex works €	
0,1	2000	JCT 100	395,-	45
0,1 1	100 1000	TB 1000-0.1F	360,-	42
0,1 1	100 1000	TB 1000-0.1FN	455,-	42
0,1 1	100 1250	TE 1250-0.1F	410,-	43
0,1 1	100 1250	TE 1250-0.1FN	520,-	43
0,1 1	100 1250	TG 1250-0.1FN	600,-	44

3



Discover more details and matching accessories online!

Practical measuring device for measuring the thickness of layers for daily use

Features

- External sensor for difficult-to-access measuring points
- Offset-Accur: This function allows you to adjust the instrument precisely on the locally measured range by a two-point calibration. This results in a superior accuracy of 1 % (or less) of the measured value
- Selectable measuring units: μm , inch (mil)
- Auto-Power-Off
- Type F: Non-magnetic coatings on iron and steel
- Type N: Coatings on non-magnetic metals
- Base plate and calibration foils included
- **1** Delivered in a robust carrying case

Technical data

- Measuring precision:
 - Standard: 3 % of measured value
 - Offset-Accur: 1 % of measured value
- Smallest sample surface (radius)
 - Type F
 - Convex: 1,5 mm
 - Flat: 6 mm
 - Concave: 25 mm
 - Type N
 - Convex: 3 mm
 - Flat: 6 mm
 - Concave: 50 mm
- Minimum thickness of base material: 300 μm
- Overall dimensions W×D×H 161×69×32 mm
- Battery operation, batteries standard (4×1.5 V AAA)
- Net weight approx. 0,75 kg



Model	Measuring range	Readout	Test object	Price excl. of VAT ex works €	Option	
					Factory calibration certificate	
SAUTER	[Max] μm	[d] μm			KERN	€
TB 1000-0.1F	100 1000	0,1 1	Type F	360,-	961-110	174,-
TB 1000-0.1FN	100 1000	0,1 1	Combination instrument Type F / Type N	455,-	961-112	245,-



3

Discover more details and matching accessories online!

Ergonomic design and external measuring head for highest ease of use

Features

- External sensor for difficult-to-access measuring points
- Data interface RS-232 as standard
- Offset-Accur: This function allows you to adjust the instrument precisely on the locally measured range by a two-point calibration. This results in a superior accuracy of 1 % (or less) of the measured value
- Selectable measuring units: μm , inch (mil)
- Auto-Power-Off
- Type F: Non-magnetic coatings on iron and steel
- Type N: Coatings on non-magnetic metals
- Base plate and calibration foils included
- **1** Delivered in a robust carrying case

Technical data

- Measuring precision:
 - Standard: 3 % of measured value or $\pm 2,5 \mu\text{m}$
 - Offset-Accur: 1 % of measured value or $\pm 1 \mu\text{m}$
- Smallest sample surface (radius)
 - Type F
 - Convex: 1,5 mm
 - Flat: 6 mm
 - Concave: 50 mm
 - Type N
 - Convex: 1,5 mm
 - Flat: 6 mm
 - Concave: 50 mm
- Minimum thickness of base material: 300 μm
- Overall dimensions WxDxH 131x65x28 mm
- Battery operation, batteries standard (4x1.5 V AAA)
- Net weight approx. 0,10 kg

STANDARD



OPTION



Model	Measuring range [Max] μm	Readout [d] μm	Test object	Price excl. of VAT ex works €	Option	
					Factory calibration certificate	
SAUTER				€	KERN	€
TE 1250-0.1F	100 1250	0,1 1	Type F	410,-	961-110	174,-
TE 1250-0.1FN	100 1250	0,1 1	Combination instrument Type F / Type N	520,-	961-112	245,-

3



Discover more details and matching accessories online!

Premium coating thickness gauge for paint layer, lacquer layer etc.

Features

- **1** LCD display, backlit, display of all information at a glance
- Offset-Accur: This function allows you to adjust the instrument precisely on the locally measured range by a two-point calibration. This results in a superior accuracy of 1 % (or less) of the measured value
- Two different measuring modes: single measurement and scan mode for continuous measurement
- Mini Statistics Kit: displays the measured result, the average value and the max and the min value
- Internal data memory for up to 99 values
- Selectable measuring units: μm , inch (mil)
- Data interface RS-232 as standard
- Type F: Non-magnetic coatings on iron and steel
- Type N: Coatings on non-magnetic metals
- Base plate and calibration foils included
- Delivered in a robust carrying case
- External sensor for difficult-to-access measuring points

Technical data

- Measuring precision:
 - Standard: 3 % of measured value or $\pm 2,5 \mu\text{m}$
 - Offset-Accur: 1 % of measured value or $\pm 1 \mu\text{m}$
- Minimum thickness of base material: $300 \mu\text{m}$
- Overall dimensions WxDxH 126x65x35 mm
- Battery operation, batteries standard (2x1.5 V AAA)
- Net weight approx. 0,10 kg

STANDARD



OPTION



Model	Measuring range [Max] μm	Readout [d] μm	Test object	Smallest sample surface (radius) mm	Price excl. of VAT ex works €	Option	
						Factory calibration certificate	
SAUTER						KERN	€
TG 1250-0.1FN	100 1250	0,1 1	Combination instrument Type F/Type N	F: Convex: 1,5/ Concave: 25 N: Convex: 1,5/ Concave: 50	600,-	961-112	245,-



3

Discover more details and matching accessories online!

New-generation measuring coating thickness gauge

Features

- **1** Accurately determines the thickness of coats of paint or varnish on iron or non-iron base material
- Combination of magnetic and eddy current measuring methods enables particularly high levels of precision and flexibility. The base material is detected automatically
- Stable, reliable performance as well as non-destructive measuring
- Measuring range up to 2000 µm
- Low-wear sensor thanks to state-of-the-art technologies
- Single and two-point calibration
- Single and repeated measurements for pass/fail assessment. The three-colour LED display shows the current value attribute (green: qualified, red: below the limit value, yellow: above the limit value)
- **2** The display rotates automatically and makes it easier for the user to read the measured values from many different angles, or alternatively it can be locked in place manually
- Selection of functions with automotive mode, voice transmission, Bluetooth App (for Android, no iOS support) and LED torch
- **3** Delivery in a practical box

Technical data

- Measuring precision: 2 % of [Max]
- Minimum thickness of base material: 300 µm
- Selectable measuring units: µm, inch (mil)
- With internal sensor
- Internal data memory for up to 55 sets of values and 60 cells per set
- Overall dimensions W×D×H 152×65×35 mm
- Net weight approx. 0,20 kg

Main scope of applications

- Automotive industry
- Metal processing
- Painting and coating
- Research facilities and test laboratories
- Quality assurance and inspection

STANDARD



OPTION



Model	Measuring range	Readout	Sensor types	Price excl. of VAT ex works €	Option	
					Factory calibration certificate	
SAUTER JCT 100	[Max] µm	[d] µm	FE NFE	395,-	KERN 961-112	€ 245,-

4



MATERIAL THICKNESS MEASUREMENT

In cases, when the walls of the item to be measured are not accessible for traditional calliper gauges, the ultrasonic measuring equipment can be used.

This measurement is based on the following principle: Ultrasonic waves are directed onto one side of the material to be measured. They move with a defined speed through the material and are reflected on the other side. The measuring device measures the time required to do this and with this, calculates the thickness of the material.

In this way the wall thickness of, for example, ship's hulls, pipes, tanks and components in sites or machines can be determined.

Ultrasonic measuring equipment can be used to measure all hard and homogeneous materials, such as metal, glass and hard plastics. This method can not be used to measure materials as, e.g. concrete, asphalt, teflon or wood.



Helga Biselli
Product Specialist
Material Thickness Measurement
Tel. +49 7433 9933-188
info@sauter.eu

Quick-Finder

Readout	Measuring range	Model	Price excl. of VAT	Page
[d]	[Max]	SAUTER	ex works	
mm	mm		€	
0,01	80	TN 80-0.01US	700,-	50
0,01	80	TN GOLD 80	770,-	49
0,01	230	TN 230-0.01US	700,-	50
0,01	300	TN 300-0.01US	800,-	50
0,01	600	TN 30-0.01EE	960,-	51
0,01	600	TN 60-0.01EE	1320,-	51
0,01	600	TO 100-0.01EE	1490,-	52
0,1	80	TN 80-0.1US	630,-	50
0,1	200	TB 200-0.1US-RED	345,-	47
0,1	200	TB 200-0.1US	405,-	47
0,1	225	TD 225-0.1US	485,-	48
0,1	230	TN 230-0.1US	630,-	50



4

Discover more details and matching accessories online!

Reliable material thickness gauge for daily use

Features

- External measuring head for difficult-to-access measuring points
- Selectable measuring units: mm, inch
- Auto-Power-Off
- Base plate for adjustment included
- Scope of delivery: Operating instructions, batteries, external measuring head (∅ 8 mm) and ultrasound contact gel
- **1** Delivered in a robust carrying case
- TB 200-0.1US-RED: Can only analyse these materials: cast iron, aluminium, copper, brass, zinc, quartz glass, polyethylene, PVC, grey cast iron, nodular cast iron, steel

Technical data

- Measuring precision: 0,5 % of [Max]
- Overall dimensions W×D×H 161×69×32 mm
- Battery operation, batteries standard (4×1.5 V AA)
- Net weight approx. 0,30 kg



Model	Measuring range	Readout	Sensor	Sound velocity	Price excl. of VAT ex works €	Option	
						Factory calibration certificate	
SAUTER	mm	[d] mm		m/sec		KERN	€
TB 200-0.1US	1,5 - 200	0,1	5 MHz ∅ 8 mm	500 - 9999	405,-	961-113	174,-
TB 200-0.1US-RED	1,5 - 200	0,1	5 MHz ∅ 8 mm	500 - 9999	345,-	961-113	174,-



Discover more details and matching accessories online!

Compact pocket-sized material thickness gauge

Features

- External measuring head for difficult-to-access measuring points
- Selectable measuring units: mm, inch
- Data interface RS-232, included
- AUTO-OFF-function to preserve the battery
- Base plate for adjustment included
- Scope of delivery: Operating instructions, batteries, external measuring head (∅ 8 mm) and ultrasound contact gel
- **1** Delivered in a robust carrying case

Technical data

- Measuring precision: 0,5 % of [Max] + 0,1 mm
- Overall dimensions W×D×H 30×65×120 mm
- Battery operation, batteries standard (4×1.5 V AAA)
- Net weight approx. 0,20 kg



Model	Measuring range	Readout	Sensor	Sound velocity	Price excl. of VAT ex works €	Option	
						Factory calibration certificate	
SAUTER	mm	[d] mm		m/sec		KERN	€
TD 225-0.1US	1,2 - 225	0,1	5 MHz ∅ 8 mm	1000 - 9999	485,-	961-113	174,-

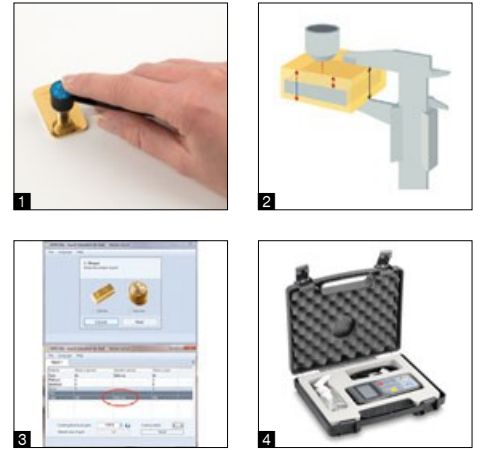

4

Discover more details and matching accessories online!

Ultrasonic measuring instrument for checking the authenticity of gold bars and coins

Features

- **1** You can use the TN-GOLD to determine whether gold or silver bars and coins are genuine or whether they contain a core of a different material
- The instrument measures the thickness of gold bars and gold coins using ultrasound
- Selectable measuring units: mm, inch
- **2** Process: Ultrasound waves are directed onto the test object using a sensor. The waves penetrate the test object, are then reflected from a surface opposite the object and then picked up again by the sensor. The measurement determined by this process will be compared with the material thickness as measured by a traditional calliper gauge. On the basis of the measurement given, false cores (Figure: grey) for example, those made of tungsten, lead, etc. can be easily identified, as the ultrasound reacts differently, compared with pure gold

- **3** SAUTER SSG software (included) can be used to calculate the sound velocity for various precious metal alloys. This makes it possible to determine whether coins or ingots contain false cores or whether they consist of one and the same material. Compatible with the following operating systems: Windows® 7/8/10
- Known additions in tested gold items – e.g. copper or silver – are compensated by the software
- In addition, the software determines the value of the gold item
- It is a test process which measures right through the whole bar or the whole coin without interference and thereby guarantees the highest level of certainty
- Internal memory for up to 20 files (with up to 100 values per file)
- Base plate for adjustment included
- Scope of delivery: Operating instructions, batteries, external measuring head (∅ 6 mm) and ultrasound contact gel
- **4** Delivered in a robust carrying case

Technical data

- Measuring precision: 0,5 % of [Max] ± 0,04 mm
- Overall dimensions W×D×H 150×74×32 mm
- Battery operation, batteries standard (2×1.5 V AA), AUTO-OFF-function to preserve the battery
- Net weight approx. 0,25 kg



Model	Measuring range	Readout	Sensor	Sound velocity	Price excl. of VAT ex works €	Option	
						Factory calibration certificate	
SAUTER	mm	[d] mm		m/sec		KERN	€
TN GOLD 80	0,75 – 80	0,01	7 MHz ∅ 6 mm	1000 – 9999	770,-	961-113	174,-



Discover more details and matching accessories online!

Portable measuring device for ultrasonic material thickness testing

Features

- External measuring head
- Data interface USB standard (only for models with readout [d] = 0,01 mm)
- Scan mode (10 measurements per sec.) or single point measuring mode possible
- Internal memory for up to 20 files (with up to 100 values per file)
- Selectable measuring units: mm, inch
- Scope of delivery: Operating instructions, batteries, device-specific measuring head and ultrasound contact gel
- **1** Delivered in a robust carrying case

Technical data

- Measuring precision: 0,5 % of [Max] ± 0,04 mm
- Overall dimensions W×D×H 150×74×32 mm
- Battery operation, batteries standard (2×1.5 V AA), AUTO-OFF-function to preserve the battery
- Net weight approx. 0,25 kg

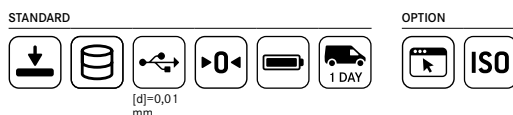

Model	Measuring range	Readout [d] mm	Sensor	Sound velocity m/sec	Price excl. of VAT ex works €	Option	
						Factory calibration certificate	
	mm				€	KERN	€
SAUTER							
TN 80-0.1US	0,75 – 80	0,1	7 MHz ø 6 mm	1000 – 9999	630,-	961-113	174,-
TN 230-0.1US	1,2 – 230	0,1	5 MHz ø 10 mm	1000 – 9999	630,-	961-113	174,-
TN 300-0.1US*	3 – 300	0,1	2,5 MHz ø 14 mm	1000 – 9999	740,-	961-113	174,-
TN 300-0.01US	3 – 300	0,01	2,5 MHz ø 14 mm	1000 – 9999	800,-	961-113	167,-
TN 80-0.01US	0,75 – 80	0,01	7 MHz ø 6 mm	1000 – 9999	700,-	961-113	174,-
TN 230-0.01US	1,2 – 230	0,01	5 MHz ø 10 mm	1000 – 9999	700,-	961-113	174,-

1 * ONLY WHILE STOCKS LAST



4

Discover more details and matching accessories online!

Hand-held measuring device for ultrasonic material thickness testing in Echo-Echo principle

Features

- External measuring head
- USB data interface, as standard
- Scan mode (10 measurements per sec.) or single point measuring mode possible
- Internal memory for up to 20 files (with up to 100 values per file)
- Selectable measuring units: mm, inch
- Two measuring modes to determine material thickness:
 - Pulse-Echo mode
 - Echo-Echo mode
- Echo-Echo measuring: Determining the actual thickness of materials irrespective of any coating which might be present. In this way, the wall thickness of pipes, for example, can be determined in a non-destructive manner, without having to remove the coating and the measurement can be shown on the display, with the adjustment for the coating thickness already taken into account

- Echo-Echo measurements are only possible with the measuring head included as part of the delivery (SAUTER ATU-US12, see internet)
- Scope of delivery: Operating instructions, batteries, external measuring head (∅ 10 mm) and ultrasound contact gel
-  Delivered in a robust carrying case

Technical data

- Measuring precision: 0,5 % of [Max] ± 0,04 mm
- Overall dimensions W×D×H 150×74×32 mm
- Battery operation, batteries standard (2×1.5 V AA), AUTO-OFF-function to preserve the battery
- Net weight approx. 0,25 kg



Model	Measuring range Echo-Echo	Measuring range Pulse-Echo	Readout	Measuring head	Sound velocity	Price excl. of VAT ex works	Option	
							Factory calibration certificate	
SAUTER	mm	mm	[d] mm		m/sec	€	KERN	€
TN 30-0.01EE	3 - 30	0,65 - 600	0,01	5 MHz ∅ 10 mm	1000 - 9999	960,-	961-113	174,-
TN 60-0.01EE	3 - 60	0,7 - 600	0,01	5 MHz ∅ 10 mm	1000 - 9999	1320,-	961-113	174,-



Discover more details and matching accessories online!

Material thickness gauge for ultrasonic material thickness testing in Echo-Echo principle

Features

- Dual measuring modes to determine material thickness:
 - Pulse-Echo mode (up to 600 mm)
 - Echo-Echo mode (up to 100 mm)
- Echo-Echo measurement: Determines the actual material thickness regardless of whether there is a coating on the base metal. In this way, the wall thickness of pipes, for example, can be determined without having to remove the coating. The measurement will be output, with the adjustment for the coating thickness taken into account
- Can be used on these materials, as well as others: Metals, plastics, ceramics, composite materials, epoxy, glass and other materials
- High-precision mode: Readout accuracy can be switched from 0.1 mm to 0.01 mm
- **1** Premium display: TFT colour display (320x240) with adjustable brightness, so that it can be read under the most varied lighting conditions
- Large internal data memory for up to 100 data sets each with 100 individual values
- Energy-saving operation with 2x AA batteries and an operating time of at least 30 hours, adjustable power-off time (sleep mode) and adjustable display switch-off (standby mode)

- **2** USB data output for easy data download from the device memory to the PC, as standard
- Triple-calibration mode: Automatic 0-point adjustment, 1-point adjustment at a specified material thickness, 2-point precision adjustment with two specified material thicknesses
- 3 different measurement modes: standard measuring (single measurement), scan mode (for continuous measurement and display of the ACTUAL value, the MIN and MAX value of the measuring sequence) and DIFF mode with calculation of the difference between the ACTUAL measured value and a manually defined nominal thickness
- Limit alarm function: Upper and lower limit adjustable. The measurement process is supported by an audible and visual signal
- Menu languages: DE, EN, FR, ES, IT
- Date and time can be adjusted. It is possible to store the measurement values with a time stamp
- Standard measuring probe SAUTER ATU-US12 included with delivery
- Scope of delivery: Operating instructions, batteries, external measuring head (∅ 10 mm) and ultrasound contact gel
- **3** Delivered in a robust carrying case

Technical data

- Measuring precision: 0,4 % of [Max] ± 0,04 mm
- Overall dimensions WxDxH 31x69x130 mm
- Battery operation, batteries standard (2x1.5 V AA), AUTO-OFF-function to preserve the battery
- Net weight approx. 0,25 kg

STANDARD



OPTION



Model	Measuring range Echo-Echo	Measuring range Pulse-Echo	Readout [d] mm	Sensor	Sound velocity m/sec	Price excl. of VAT ex works €	Option	
							Factory calibration certificate	
SAUTER	mm	mm					KERN	€
TO 100-0.01EE	3 - 100	0,7 - 600	0,01	5 MHz ∅ 10 mm	200 - 19999	1490,-	961-113	174,-

5



HARDNESS TESTING OF PLASTICS (SHORE)

To determine the hardness of plastics, in 1915 Albert Shore developed an extremely simple process: A pin made of hardened metal and of a defined shape is held by a spring and is then pushed into the test item. Depending on the depth of the penetration, the material tested is either harder or softer. This procedure is described in DIN ISO 48-4.

Currently, there are two types of devices used for this test: Mechanical measuring devices with drag indicator and electronic measuring devices.

Both types of measuring devices can be operated with test stands (such as the SAUTER TI series). With a test stand, measurements can be carried out more consistently and accurately.

At this time, KERN does not calibrate Shore hardness testing instruments. As an alternative, we recommend that the measuring device is operated with a calibrated kit of hardness comparison plates (such as SAUTER AHBA 01).



Irmgard Russo
Product Specialist
Hardness Testing of Plastics
Tel. +49 7433 9933-208
info@sauter.eu

Quick-Finder

Readout	Measuring range	Hardness scales	Model	Price excl. of VAT ex works €	Page
[d]	[Max]		SAUTER		
HS	HS		TI-AC	270,-	56
			TI-ACL	365,-	56
			TI-HEA	900,-	58
			TI-D	355,-	56
			TI-DL	445,-	56
			TI-HED	990,-	58
0,1 H0	100 H0	Shore 0	H00 100-1	360,-	55
0,1 HA	100 HA	Shore A	HDA 100-1	420,-	55
0,1 HA	100 HA	Shore A	HEA 100	620,-	57
0,1 HD	100 HD	Shore D	HDD 100-1	420,-	55
0,1 HD	100 HD	Shore D	HED 100	720,-	57
1 HA	100 HA	Shore A	HBA 100-0	125,-	54
1 HAO	100 HAO	Shore A0	HBO 100-0	130,-	54
1 HD	100 HD	Shore D	HBD 100-0	170,-	54



Discover more details and matching accessories online!

Compact handheld durometer with drag indicator

Features

- Typical application: measurement of penetration (Shore)
- Particularly recommended for internal comparison measurement. Standard calibrations e.g. to DIN 48-4 are not possible because of very narrow standard tolerances
- Shore A: Rubber, elastomers, neoprene, silicone, vinyl, so plastics, felt, leather and similar material
- Shore D: Plastics, formica, epoxides, plexiglass etc.
- Shore A0: Foam, sponge etc.
- Max mode: Records the peak value indication by drag pointer
- Can be attached to the test stands SAUTER TI-AC (for Shore A and A0), SAUTER TI-D (for Shore D)
-  Delivery in a plastic box
- The measuring tips are not interchangeable

Technical data

- Measuring precision: 3 % of [Max]
- Material thickness of the sample, min. 6 mm
- Screws to screw on to the TI: M7 fine thread
- Overall dimensions W×D×H 115×60×25 mm
- Net weight approx. 0,15 kg

STANDARD



Model	Hardness scales	Measuring range	Readability	Price excl. of VAT ex works €
SAUTER		[Max]	[d]	
HBA 100-0	Shore A	100 HA	1 HA	125,-
HBO 100-0	Shore A0	100 HAO	1 HAO	130,-
HBD 100-0	Shore D	100 HD	1 HD	170,-



5

Discover more details and matching accessories online!

Professional Shore hardness tester

Features

- To measure the hardness of plastics through penetration measurement
- Particularly recommended for internal comparison measurement. Standard calibrations e.g. to DIN 48-4 are not possible because of very narrow standard tolerances
- Shore A: Rubber, elastomers, neoprene, silicone, vinyl, so plastics, felt, leather and similar material
- Shore 0: foam, sponge
- Shore D: Plastics, formica, epoxides, plexiglass etc.
- Can be attached to the test stands TI-ACL (for Shore A and 0), TI-DL (for Shore D) to improve the measurement result
- Large display with backlight
- Selectable: AUTO-OFF function or continuous operation, battery level indicator
- **1** Delivered in a robust carrying case

Technical data

- Tolerance: 1 % of [Max]
- Material thickness of the sample, min. 6 mm
- Transfer via RS-232 to the PC, e.g. to Microsoft Excel®
- Battery operation, batteries standard (2x1.5 V AAA)
- Overall dimensions WxDxH 125x70x27 mm
- Net weight approx. 0,20 kg

STANDARD



OPTION



Model	Hardness scales	Measuring range	Readability	Price excl. of VAT ex works €
SAUTER		[Max]	[d]	
HDA 100-1	Shore A	100 HA	0,1 HA	420,-
HDO 100-1*	Shore 0	100 HO	0,1 HO	360,-
HDD 100-1	Shore D	100 HD	0,1 HD	420,-

1 * ONLY WHILE STOCKS LAST

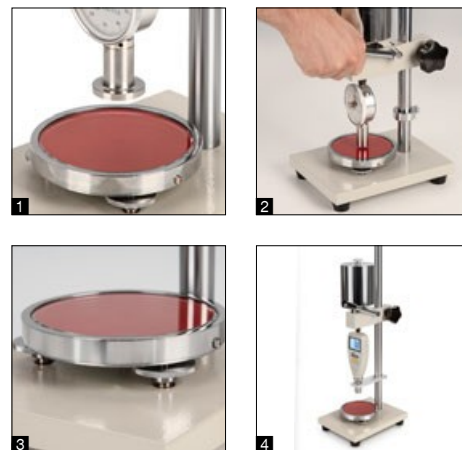

Discover more details and matching accessories online!

5

Lever operated test stand for hardness testing with base plate made of glass

Features

- For Shore hardness testing of plastics, leather etc.
- **1** Glass plate: high measurement accuracy by means of superior hardness of the glass plate
- **2** Mechanical construction: Robust design enables accurate measuring movements
- **3** Level adjustment: For the precise levelling of the base plate, e.g. for the correction of inhomogeneous test objects
- **4** SAUTER TI-DL: with exchangeable longer column for use with digital hardness tester HD
- Hardness tester is not included with delivery

Operation:

1. The SAUTER hardness testing device HB/HD is fitted in a suspended position
 2. The test object is placed on the round testing table right under the durometer measuring tip
 3. By pressing the lever down, the test weight will be released, and this then presses the measuring tip into the test object with its own weight (see test force hardness measurement)
- The accuracy of the displayed result is about 25 % higher than in a manual operated test

Technical data

- Stroke length: 15 mm
- Base plate \varnothing 75 mm

STANDARD



Model	Hardness scales	Test force hardness measurement	Test object height [Max] mm	Overall dimensions W×D×H mm	Net weight approx. kg	Price excl. of VAT ex works €
SAUTER		N				
TI-AC	Shore A	10	60	150×200×330	7	270,-
TI-D	Shore D	50	60	150×200×400	8	355,-
TI-ACL	Shore A	10	290	150×200×580	6	365,-
TI-DL	Shore D	50	290	150×200×580	9	445,-



Discover more details and matching accessories online!

5

Shore hardness tester with extensive functionality

Features

- To measure the hardness of plastics through penetration measurement
- **1** Shore A: Rubber, elastomers, neoprene, silicone, vinyl, so plastics, felt, leather and similar material
- **2** Shore D: Plastics, formica, epoxides, plexiglass etc.
- Different measuring modes: Average value, maximum value, chronological sequence
- Limit alarm function, which triggers an audible and visual signal when the value goes below or above the defined limits
- Entering the workpiece number is possible
- Setting the measuring time from 0 to 99 seconds
- Recommended for internal comparison measurement
- **3** Can be attached to the test stands SAUTER TI-HEA (for Shore A), SAUTER TI-HED (for Shore D) to improve the measurement result, see internet
- Large display with backlight
- Battery status indicator
- USB data interface, as standard
- **4** Delivered in a robust carrying case

Technical data

- Test force hardness measurement
SAUTER HEA: 10 N
SAUTER HED: 50 N
- Tolerance: 1 % of [Max]
- Diameter of measuring probe: 18 mm
- Material thickness of the sample, min. 6 mm
- Internal memory for up to 500 results
- Rechargeable battery pack integrated, as standard, operating time up to 20 h without backlight, charging time approx. 3 h
- Overall dimensions W×D×H 153×50×29 mm
- Net weight approx. 0,20 kg

STANDARD



Model	Hardness scales	Measuring range	Readability	Price excl. of VAT ex works €
SAUTER		[Max]	[d]	
HEA 100	Shore A	100 HA	0,1 HA	620,-
HED 100	Shore D	100 HD	0,1 HD	720,-



Discover more details and matching accessories online!

Test stand for hardness testing Shore A and D

Features

- High-quality test stand for Shore hardness testing of plastics in industry and the laboratory
- **1** One test stand for two hardness scales: You just need to screw the additional weight TI-HE onto the TI-HEA test bench, so that this can then also be used for Shore D hardness testing, see internet
- **2** Level adjustment: For the precise levelling of the steel base plate, e.g. for the correction of inhomogeneous test objects
- Robust design enables accurate measuring movements
- **3** Simple handling means that you can achieve repeatable measuring results
- Hardness tester is not included with delivery

Technical data

- Maximum stroke length: 20 mm
- Maximum test object height: 50 mm
- Base plate \varnothing 115 mm

STANDARD



Model	Hardness scales	Test force hardness measurement	Overall dimensions W×D×H mm	Net weight approx. kg	Price excl. of VAT ex works €
SAUTER		N			
TI-HEA	Shore A	10	200×200×390	6	900,-
TI-HED	Shore D	50	200×200×470	10	990,-

6



HARDNESS TESTING OF METALS (LEEB)

Determining the hardness of metals is of particular significance during the preparation and use of metallic materials. Usually, hardness is determined using test machines in accordance with Vickers, Rockwell or Brinell.

For mobile measurements, the rebound method according to Dietmar Leeb, which was first used in 1978, has prevailed. To do this, a standardised impact body (such as SAUTER AHMO D01) is shot against the item to be tested. The rebound of the impact body leads to a deformation of the upper surface, which results in a loss of kinetic energy. This loss of energy is determined by measuring the speed and herefrom the Leeb hardness value (HL) is calculated.

These measuring devices can be used in any location. Usually they are equipped with a large internal data memory, which allows to record the measurements at goods receipt or in production.

Our range is equipped with compact measuring devices of the so-called "Pen Type" shape (HN-D) or measuring devices with external sensors connected by cables.



Helga Biselli
Product Specialist
Hardness Testing of Metal
Tel. +49 7433 9933-188
info@sauter.eu

Quick-Finder

Readout	Measuring range	Sensor	Model	Price excl. of VAT	Page
[d] HL	[Max] HL		SAUTER	ex work €	
1	960	D	HN-D	930,-	62
1	960	D	HMM-NP	1060,-	61
1	960	D	HMM	1 180,-	61
1	960	D	HK-D	1420,-	60
1	960	D	HK-DB	1520,-	60
1	960	D	HMO	2020,-	63



Discover more details and matching accessories online!

6

Premium Leeb hardness tester – also with hardness comparison block included

Features

- External impact sensor standard (Type D)
- Mobility: In comparison with stationary table-top devices and testing devices with an internal sensor, using the SAUTER HK-D offers the highest level of mobility and flexibility
- All measurement directions possible (360°) thanks to an automatic compensation function
- **1** SAUTER HK-DB: Hardness comparison block, hardness approx. 800 HLD, included in delivery
- Measurement value display: Rockwell (Type A, B, C), Vickers (HV), Shore (HS), Leeb (HL), Brinell (HB)

- Internal memory for up to 600 data groups, with up to 32 values per group forming the average value of the group
- Mini statistics function: displays the measured result, the average value, the impact direction, date and time
- Automatic unit conversion:
The measuring result is automatically converted into all specified hardness units
- Measuring with tolerance range and programmable limit values. The process is supported by an audible and visual signal
- Matrix display: Backlit multi-function display
- Robust metal housing
- **2** Delivered in a robust carrying case

Technical data

- Precision: $\pm 1\%$ at 800 HLD
- Minimum sample radius (concave/convex): 50 mm (with support ring: 10 mm)
- Thinnest measurable material thickness: 3 mm, with coupling on fixed base
- The lowest weight of the test item on solid support unit: 2 kg with fixed coupling
- Battery operation, 2x1.5 V AA standard, operating time up to 200 h
- Permissible ambient temperature -10 °C/40 °C
- Overall dimensions WxDxH 132x82x31 mm

STANDARD



HK-DB

OPTION



HK-D

Model	Sensor	Measuring range	Readout	Test block	Net weight	Price excl. of VAT ex works	Option	
							Factory calibration certificate	
SAUTER		HL	[d] HL	Typ D/DC approx. 800 HL	approx. kg	€	KERN	€
HK-D	D	170 – 960	1	not standard	0,45	1420,-	961-131	174,-
HK-DB	D	170 – 960	1	standard	0,45	1520,-	961-131	174,-

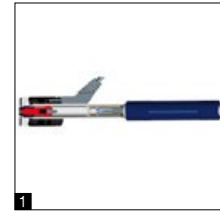

Discover more details and matching accessories online!

Advanced features for demanding applications

Features

- **1** Impact (rebound) sensor: The bounce module is accelerated by a spring against the item being tested. Depending on how hard the object is, the kinetic energy of the module will be absorbed. The speed reduction will be measured and converted to Leeb hardness values
- External impact sensor (Type D) included
- High levels of mobility and flexibility in comparison with stationary table-top devices and hardness testing devices with internal sensors
- All measurement directions possible (360°) thanks to an automatic compensation function
- **2** Hardness test block for calibration included (790 ± 40 HL)
- Internal memory for up to 9 measurement values

- Mini statistics function: displays the measured result, the average value, the impact direction, date and time
- SAUTER HMM: Infrared printer for direct output of the measuring results is included with delivery
- SAUTER HMM-NP: identical product features as the SAUTER HMM model, but comes without the printer
- Measurement value display: (B and C), Vickers (HV), Brinell (HB), Shore (HSD), Leeb (HL), tensile strength (MPa)
- Automatic unit conversion: The measuring result is automatically converted into all specified hardness units
- **3** Delivered in a robust carrying case

Technical data

- Precision: ± 1 % at 800 HLD (± 6 HLD)
- Measuring range tensile strength: 375–2639 MPa (steel)
- Minimum sample weight on a solid and stable support: 2 kg with fixed coupling
- Minimum sample material thickness: 3 mm with coupling on fixed base
- Minimum sample radius (concave/convex): 50 mm (with support ring: 10 mm)
- Batteries included, 3×1.5 V AAA, operating time up to 30 h, AUTO-OFF-function to preserve the battery
- SAUTER HMM: External mains adapter for printer, as standard
- Overall dimensions W×D×H 150×80×30 mm

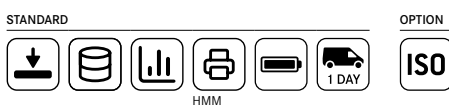

Model	Sensor	Measuring range	Readout	Net weight	Price excl. of VAT ex works	Option	
						Factory calibration certificate	
SAUTER		HL	[d] HL	approx. kg	€	KERN	€
HMM	D	170 – 960	1	0,25	1180,-	961-131	174,-
HMM-NP	D	170 – 960	1	0,25	1060,-	961-131	174,-



6

Discover more details and matching accessories online!

“Pen type“ Leeb hardness tester for mobile hardness testing of metals

Features

- User-friendly operation: The compact version enables the product to be used in a significantly wider range of applications compared with traditional devices
- The measuring device has been designed for one-hand operation and this allows the user to work more quickly and flexibly
- Modern LCD display: Optimised for industrial applications: increased luminosity and backlight can be switched on, that way the display can be read from any angle

- All measurement directions possible (360°) thanks to an automatic compensation function
- Internal impact sensor included (Type D)
- Measurement value display: (B and C), Vickers (HV), Brinell (HB), Leeb (HL)
- Standard block for calibration not included in scope of delivery
- Internal data memory for up to 500 measurements with date and time
- Data interface USB, including USB interface cable
- **■** Delivered in a robust carrying case

Technical data

- Measurement uncertainty ± 4 HLD
- Minimum sample weight on a solid and stable support: 2 kg with fixed coupling
- Thinnest measurable material thickness: 3 mm, with coupling on fixed base
- Rechargeable battery pack integrated, as standard, operating time up to 16 h without backlight, charging time approx. 3 h
- Mains adapter external, standard
- Overall dimensions WxDxH 22x35x147 mm
- Net weight approx. 0,20 kg



Model	Sensor	Measuring range	Readout	Price excl. of VAT ex works €	Option	
					Factory calibration certificate	
			[d] HL	€	KERN	€
SAUTER HN-D	D	170 – 960	1	930,-	961-131	174,-



Discover more details and matching accessories online!

Advanced features for professional applications

Features

- LCD touchscreen with touch pen
- Automatic recognition of the impact (rebound) sensor connected to the SAUTER HMO
- Mobility: In comparison with stationary table-top devices and testing devices with an internal sensor, using the SAUTER HMO offers the highest level of mobility and flexibility
- All measurement directions possible (360°) by defining the direction of impact on the device
- USB socket for connection to the printer and charging the batteries
- **1** Hardness test block for calibration included
- Internal data memory for up to 500 values
- Mini statistics function: Displays the measure value, the average value, the difference between the maximum and minimum values, date and time
- Measurement value display: (B and C), Vickers (HV), Brinell (HB), Leeb (HL), tensile strength (MPa)
- Automatic unit conversion:
The measuring result is automatically converted into all specified hardness units
- **2** Delivered in a robust carrying case

Technical data

- Precision: $\pm 1\%$ at 800 HLD (± 6 HLD)
- Measuring range tensile strength: 375–2639 MPa (steel)
- Minimum sample weight on a solid and stable support: Sensor D + DC: 2 kg with fixed coupling
- Minimum sample material thickness: Sensor D + DC: 3 mm with coupling on fixed base
- Minimum sample radius (concave/convex): 50 mm (with support ring: 10 mm)
- Internal rechargeable battery pack, operating time up to 50 h without backlight, charging time approx. 8 h, standard
- Mains adapter included
- Overall dimensions W×D×H 24×83×135 mm
- Net weight approx. 4,6 kg

STANDARD



OPTION



Model	Sensor	Measuring range	Readout	Price		
				excl. of VAT	Option	
			[d] HL	€	Factory calibration certificate	€
SAUTER		HL				
HMO	D	170 – 960	1	2020,-	KERN 961-131	174,-

JUST SURFACED!



Take advantage of the latest innovations in measuring and weighing technology and dive into a world of precision, quality and versatility. Discover over 5,000 high-quality products and numerous services – perfectly tailored to your professional requirements. The new KERN product catalogues 2026 are available in five languages!

BALANCES AND TEST SERVICE

Get a full overview of the wide range from KERN, including our high-quality balances, test weights and services such as verification and calibration services.

MEDICAL SCALES

Our medical scales cover the full array: baby scales to personal scales, chair scales and adiposity scales through to hand grip dynamometers, pharmaceutical balances and veterinary scales, we offer the complete range.

MICROSCOPES AND REFRACTOMETERS

Discover our large range of optical instruments, such as, for example our compound, polarisation or fluorescence microscopes, or our analogue and digital refractometers.

SAUTER MEASURING TECHNOLOGY

From force-measuring devices through to hardness measuring equipment and on to measuring cells – you can find everything you need for accurate, reliable measurements.

TEST SERVICE BROCHURE

Detailed information on all topics pertaining to the calibration and conformity assessment of balances, test weights and measuring devices.

All catalogues and information material are available for you to download as PDF files from our website:
www.kern-sohn.com/shop/en/DOWNLOADS



HARDNESS TESTING OF METALS (UCI)

Ultrasonic contact impedance (UCI) hardness testing devices are filling wisely a void in the area of hardness testing.

This area of testing is, on one hand, dominated by mobile hardness testing devices which are using the Leeb procedure and, on the other hand, by stationary hardness testing devices which are predominantly carrying out destructive tests.

Because of the high demands required by this system on the minimum weight and thickness of the test object, the Leeb procedure is not suitable for the majority of tests for small test objects. A good example of this is hardness testing of the flanks of gear wheels. Often in this test, the question is whether the flanks have been hardened or whether the hardened layer has already been removed.

UCI hardness testing devices therefore are offering significantly better measurement performance at small test objects in comparison with Leeb hardness testing devices.

One advantage of the UCI hardness testing devices compared with stationary hardness testing machines is, that the test object does not have to be cut out of the whole object.

By using the optional support rings, the minimum weight of the test object can even be reduced from 300 g to 100 g.

By means of optional ISO calibration, SAUTER UCI hardness testing devices can be used not only for internal testing purposes but also for measurements where the results have to be changed externally.



Helga Biselli
Product Specialist
Hardness Testing of Metals (UCI)
Tel. +49 7433 9933-188
info@sauter.eu

Quick-Finder

Hardness scale	Model	Price excl. of VAT ex works €	Page
	SAUTER		
HV 1	HO 1K	5200,-	66
HV 2	HO 2K	5200,-	66
HV 5	HO 5K	5200,-	66
HV 10	HO 10K	5200,-	66



7

Premium UCI hardness testing device for Rockwell, Brinell and Vickers



Mini statistics function:

Display of the measuring result, the number of measurements, the maximum and minimum value as well as the average value and the standard deviation



Scope of delivery:

Standard block for calibration (approx. 61 HRC), USB cable, display unit, UCI sensor unit, transport case, software to transfer the saved data to the PC, protective case (turquoise), further accessories



Test stand for repeatable movements during testing. In this way you can avoid errors which could occur in manual handling of the sensor. This ensures even more stable measurements and more precise measuring results, see internet

Features

- This ultrasound hardness testing device is ideally suited for mobile hardness testing, where the main emphasis is on obtaining rapid and precise results
- The SAUTER HO measures by using a vibrating rod with ultrasonic frequency and which is pressed onto the sample with a predefined test force. At the lower end there is a Vickers indenter. Its resonant frequency increases as soon as an indentation is created when it comes into contact with the sample. This frequency displacement is matched with the corresponding Vickers hardness using appropriate adjustment of the device
- The SAUTER HO ultrasound hardness testing system is primarily used for measuring small forgings, castings, welding points, punched parts, casting tools, ball bearings and the flanks of gear wheels as well as for measuring the influence of warmth or heat
- Advantages compared with Rockwell and Brinell: Almost non-destructive testing by smaller test force
- Advantages compared with Vickers: Demanding optical measuring is not required. You can therefore carry out measurements directly on-site, for example, on a permanently installed workpiece
- Advantages compared with Leeb: The high requirements concerning the proper weight of the test object can be widely omitted
- The device meets following technical standards: DIN 50159-1; ASTM-A1038-2005; JB/T9377-2013
- Measurement data memory saves up to 1000 measurement groups each with 20 individual values
- The device can be set to both standard hardness test blocks and also to up to 20 reference calibration values. In this way different materials can be measured rapidly without having to re-adjust for individual materials

Technical data

- Measuring ranges: HRC: 20,3–68; HRB: 41–100; HRA: 61–85,6; HV: 80–1599; HB: 76–618; Tensile strength: 255–2180 N/mm²
- Measurement precision: ± 3 % HV; ± 1,5 HR; ± 3 % HB
- Display units: HRC, HV, HBS, HBW, HK, HRA, HRD, HR15N, HR30N, HR45N, HS, HRF, HR15T, HR30T, HR45T, HRB.
- Minimum weight of the test object: 300 g for direct measurement with the sensor (included); 100 g with supporting ring (optional)
- Minimum dimensions the test surface size around: approx. 5×5 mm (recommended)
- Rechargeable battery pack integrated, as standard, operating time up to 12 h without backlight, charging time approx. 8 h
- Overall dimensions W×D×H 28×83×160 mm
- Net weight approx. 0,95 kg

Discover more details and matching accessories online!



Model	Hardness scale	Min. weight of test item	Min. thickness of test item	Price excl. of VAT ex works €	Option	
					Factory calibration certificate	
		g	mm		KERN	€
SAUTER HO 1K	HV 1	300	2	5200,-	961-270	375,-
HO 2K	HV 2	300	2	5200,-	961-270	375,-
HO 5K	HV 5	300	2	5200,-	961-270	375,-
HO 10K	HV 10	300	2	5200,-	961-270	375,-

8



OCCUPATIONAL SAFETY, ENVIRONMENT

Prevention of accidents as well as modern health care have got the same operational starting point in many countries. With industrialisation and the formation of conurbations, transport infrastructures and large companies, regular preventive medical examinations were introduced for wide sections of the population.

In addition to preventive medical examinations, monitoring of working conditions with defined limits was also introduced. To date, the regular checking of these limits as part of safety and accident prevention measures is domiciled as a business responsibility up till now.

For this purpose, SAUTER provides a targeted selection of the most commonly-used instruments in general measuring technology. They can be used to measure environmental influences such as noise (acoustic pressure) or light.

For regular calibration, our pick-up and return service can be used, which will save you a lot of efforts and expenses.



Irmgard Russo
Product Specialist
Occupational Safety / Environment
Tel. +49 7433 9933-208
info@sauter.eu

Quick-Finder

Readout	Measuring range	Model	Price excl. of VAT ex works €	Page
[d]	[Max]	SAUTER		
-	420 °C	JIT 100	99,-	69
-	1100 °C	JIT 200	160,-	69
0,1	130	SU 130	120,-	72
0,1	134	SW 1000	2100,-	73
0,1	136	SW 2000	1110,-	73
0,1 1 10 100	200 2000 20000 200000	SO 200K	84,-	70
0,1 1 10 100	200 2000 20000 200000	SP 200K	105,-	71



Discover more details and matching accessories online!

Infrared thermometer for industry, environmental engineering and maintenance work

Features

- **1** Determines the temperature of surfaces precisely
- Light EBTN colour display for optimum readability under the most varied environmental conditions
- MAX/MIN/AVG/DIF value memory to store the highest, lowest and average measured temperatures in a defined period of time as well as the difference between the highest and lowest value
- Limit-alarm function with memory for five temperatures or emission values respectively, which trigger an audible and visual signal (three-colour LED) when the value goes below or above these values
- **2** Main application areas:
Temperature measurement in industry (e.g. metal processing, machine construction), environmental engineering, agriculture, laboratory and maintenance work (e.g. wind turbines)

SAUTER JIT 100

- Laser (Class 2 < 1 mW) to mark the measurement point
- Locked measurement for processes where the temperature needs to be monitored, i.e. the measured values are locked and protected from external influences
- With mounting hole for column mount

SAUTER JIT 200

- Double laser for even better positioning
- Hold function for measurements
- Time-based measurement is possible
- Internal data memory for up to 99 measurements with date and time
- With mounting thread for column mount

Technical data

- Laser class 2
- Tolerance range: +/- 1,5 °C or +/- 1,5 %
- Battery operation, 9 V block standard, operating time up to 9 h

STANDARD



Model	Measuring range	D:S Optic	Overall dimensions W×D×H	Net weight approx.	Price excl. of VAT ex works €
SAUTER	°C		mm	kg	
JIT 100	-32 - 420	12:1	162×90×48	0,25	99,-
JIT 200	-32 - 1100	20:1	179×127×53	0,35	160,-



Discover more details and matching accessories online!

8

Photometer for precise light measurement up to 200,000 Lux

Features

- Helps to determine if workplace lighting meets standard requirements, e.g. DIN EN 12464-1 "Lighting of workplaces indoors"
- Photo sensor: silicon diode
- Cosine correction for angular incident light
- Track function for continuous recording of changing environmental conditions
- Peak Hold function to capture peak value
- Selectable measuring units: fc (foot-candle), lux
- Sturdy protective cover for the photo sensor
- Increased service life: Impact protection by means of a protective casing
- **1** Delivery in a robust box

Technical data

- Measuring frequency: 2 Hz
- Cable length (Photo sensor) approx. 1 m
- Battery operation, batteries standard (9 V block), AUTO-OFF-function to preserve the battery
- Overall dimensions WxDxH 160x72x40 mm
- Net weight approx. 0,25 kg

STANDARD



OPTION



Model	Measuring range	Readout	Price excl. of VAT ex works €	Option	
				Factory calibration certificate	
SAUTER	[Max] lx	[d] lx		KERN	€
	200	0,1			
	2000	1			
SO 200K	20000	10	84,-	961-190	340,-
	200000	100			



Discover more details and matching accessories online!

Compact photometer, optimised for accurate light measurement, including LED light measurement

Features

- For measuring illumination of office workstations, production workstations, etc.
- Photo sensor: silicon diode, filtered
- Cosine correction for angular incident light
- Data-hold function, to freeze the current measurement
- **1** Rotatable sensor unit (+90 and -180°) for optimum alignment to the light source
- Track function for continuous recording of changing environmental conditions
- By pressing the key, the current measured value can be frozen until the key is pressed again
- Selectable measuring units: fc (foot-candle), lux
- Easy to toggle between units at the press of a button
- Option of fitting a stand on the rear of the housing, 1/4" thread
- Sturdy protective cover for the photo sensor

Technical data

- Measurement precision up to 20.000 Lux: ± 4 % of the result + 10 scale intervals
- Measurement precision from 20.000 Lux: ± 5 % of the result + 10 scale intervals
- Repeatability: ± 2 % of [Max]
- Temperature error: ± 0,1 % von [Max]/°C
- Measuring frequency: 2 Hz
- Ready for use: Batteries included, 9 V block, operating time up to 200 h
- Overall dimensions W×D×H 185×68×38 mm
- Net weight approx. 0,15 kg

STANDARD OPTION

  1 DAY 

Model	Measuring range	Readout	Price excl. of VAT ex works €	Option	
				Factory calibration certificate	€
SAUTER SP 200K	[Max] lx	[d] lx	105,-	KERN	€
	200	0,1			
	2000	1			
	20000	10			
	200000	100		961-190	340,-



Discover more details and matching accessories online!

Versatile sound level meter

8

Features

- Sound level meter with basic functions for measuring noise in areas such as, environment, mechanical applications, car industry and much more
- Measures the sound intensity in the workplace
- Helps in differentiating between normal noise influences, and excessive noise, nuisances e.g. in a production hall
- **1** Data interface RS-232, included
- Multi measuring functions:
Lp: Standard sound level measuring function
Leq: Energy equivalent sound level measuring mode (type A)
Ln: Shows the deviation from a pre-defined limit in %

- Selectable methods of evaluation:
A: As sensitive as the human ear
C: Sensitive for noisier environmental conditions, where there are machines, plant, motors etc.
F: For areas with constant sound intensity
- Limit value function: programmable value for the maximum level value
- Track function for continuous recording of changing environmental conditions
- Peak Hold function to capture peak value
- Internal memory for 30 measured values, transferable to PC with SAUTER ATC-01
- **2** Delivered in a robust carrying case

Technical data

- Measuring precision: 3 % of [Max]
- Battery operation, batteries standard (4×1.5 V AAA)
- Overall dimensions W×D×H 223×62×25 mm
- Net weight approx. 0,20 kg



Model	Type	Measuring range [Min]-[Max] dB	Readout [d] dB	Price excl. of VAT ex works €	Option	
					Factory calibration certificate	
SAUTER SU 130	Lp A	30 - 130	0,1	120,-	KERN	€
	Leq C				961-281	250,-
	Ln F					



First-class professional Class I, Class II sound level meter

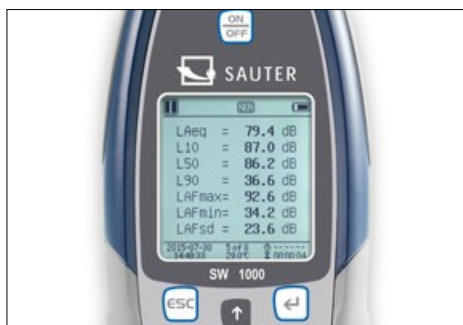

Data logging function with date and time in the device...



... and data transfer using MicroSD (4G) memory card (included in delivery), RS-232 or USB

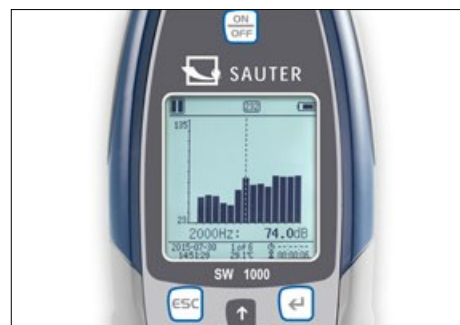

Different sound pressure levels can be selected, such as, LAeq, LcPeak, LaF, LaFMax, LaFMin, SD, SEL, E



Features

- Ideal for measurements for workplaces outdoor, e.g. at airports, on building sites, in road traffic etc. with wide frequency access
- Modern microcontroller architecture for increased stability and accuracy
- A specially-developed algorithm permits a compliant dynamic range of more than 120 dB! (SW 1000: > 123 dB; SW 2000: > 122 dB)
- Three profiles and 14 user-defined measurements can be calculated in parallel with different frequency and time weighting
- LN statistics and display of the graph showing the progression of time
- User-defined integral interval measurement up to a maximum of 24 hours is possible
- Frequency weighting (filter) A, B, C, Z
- Time interval during measurement: F (fast), S (slow), I (pulse)

- Freely-definable limits for the output of an optical alarm signal
- Peak Hold function to capture peak value
- Octave function for targeted sound analysis, can be expanded to 1/3 octave through the purchase of a licence
- TRACK function with graphic display of a measurement
- Calibration mode (with optional calibrator)
- Trigger mode: external start/stop of measurement via 3,5 mm connector
- Automatic measurement for timer function is possible
- Operating languages: EN, DE, FR, ES, PT
- Option of fitting a stand on the rear of the housing, 1/4" thread
-  Delivery in robust transport case

Discover more details and matching accessories online!

Technical data

- Applicable standards:
 - IEC61672-1:2014-07
 - GB/T3785.1-2010
 - 1/1 Octave in accordance with IEC 61260:2014
- 1/2" microphone
- Output (direct or alternating current) AC (max 5 VRMS), DC (10 mV/DB)
- Mains adapter external, standard
- Battery operation possible, 4x1.5 V AA not included, operating time up to 10 h
- Permissible ambient temperature -10 °C/50 °C
- Overall dimensions WxDxH 200x85x40 mm
- Net weight approx. 0,40 kg



Model	Accuracy class	Measuring range linear [Min]-[Max] dB	Readout [d] dB	Frequency range [Min]-[Max] kHz	Sensitivity mv/Pa	Price excl. of VAT ex works €	Option	
							Factory calibration	certificate
SAUTER							KERN	€
SW 1000	Class 1	20 - 134	0,1	0,01 - 20	50	2100,-	961-281	250,-
SW 2000	Class 2	25 - 136	0,1	0,02 - 12,5	40	1110,-	961-281	250,-



COLOUR MEASUREMENT

Everything is so bright and colourful here...

The colours all around us are of vital importance in describing our world. But because perception of colour is different from person to person and is influenced by factors such as age and gender, it is highly subjective. Therefore, in industrial colour schemes, sensors are used to produce a comparable, objective and repeatable measurement result.

To achieve this all factors which could influence the perceived colours are reduced to a minimum. These may be, for example, the lighting, background or surface.

By doing this it is possible to imitate human perception of colour, but at the same time obtain measurements in a technical way such that even the smallest differences or deviations in colour are detected. In many sectors, the colour of the product is an indicator of quality, particularly for products which are in circulation for a long period of time. It is very important in this case that the visual impression of the products remains constant at all times, so as to avoid consumer confusion.



Dietmar Paul
Product Specialist
Colour Measurement
Tel. +49 7433 9933-216
info@sauter.eu

Quick-Finder

Measuring aperture	Model	Price excl. of VAT ex works €	Page
	SAUTER		
MAV: \varnothing 8 mm / \varnothing 10 mm, SAV: \varnothing 4 mm / \varnothing 5 mm	JCS 200	1 850,-	76
MAV: \varnothing 8 mm / \varnothing 10 mm, SAV: \varnothing 4 mm / \varnothing 5 mm, LAV: 1 x 3 mm	JCS 100	3 150,-	76



9

Versatile colour spectrometer for professional use



Determine wavelengths and colour spectra precisely, qualify and compare colours using current standards



Characterise colours comprehensively – taking the gloss into account or not



Developed for quality control of colours in the textile, printing and plastics industry and many other sectors



Discover more details and matching accessories online!

Features

- Precise colour spectrometer for determining wavelengths and colour spectra
- Identifies a range of chroma parameters
- You can select the standard observation angle as 2 or 10 degrees, several light source modes, several colour spaces
- Geometric optical D/8 structure, i.e. the angle at which the light is reflected from the sample is recorded is 8 degrees. This structure is suitable for highly diverse materials and surfaces
- Measurement process: the dual optical trail system simultaneously records the SCI and the SCE spectrum of a sample. This combination enables precise, comprehensive characterisation of the colour, both taking the gloss into account and not taking the gloss into account
- With LED light source to support fluorescence measurements
- The integrated white panel for reference is protected against contamination and guarantees the measuring accuracy

- Portable design, robust construction
- Wobble-free, dustproof and shockproof
- Full spectrum with long service life and low power consumption
- **■** Developed for quality control of colours, in the textile, printing, ceramic, food processing and cosmetics industries, for example
- Ideal for use in the laboratory and industry:
 - USB data interface, as standard
 - Rapid, accurate measurement of the SCI and SCE spectrum, simultaneously within a second
 - Colour display with simple touch operation
- Offers the most varied calibration algorithms
- Supports several national and international standards and parameters, including spectral reflectance, WI (ASTM E313, CIE/ISO, AATCC and Hunter), YI (ASTM 01925, ASTM 313), colour spectrum index of Mt, touch colour fastness, colour authenticity, thickness, coverage rate, 555 colour classification as well as Munsell (C2)

Technical data

- Displayed accuracy: 0,01 of [Max]
- Standard deviation: 0,08
- Light source: LED, UV
- Overall dimensions W×D×H 188×94×68 mm
- Net weight approx. 0,30 kg



Model	Measuring aperture	Observation angle	Price excl. of VAT ex works €
SAUTER			
JCS 100	MAV: \varnothing 8 mm / \varnothing 10 mm, SAV: \varnothing 4 mm / \varnothing 5 mm, LAV: 1×3 mm	2° 10°	3150,-
JCS 200	MAV: \varnothing 8 mm / \varnothing 10 mm, SAV: \varnothing 4 mm / \varnothing 5 mm	2° 10°	1850,-

10

LOAD CELLS

Various accuracy classes with nominal loads from 300 g to 100 t and protection classes up to IP69K are available to you in the SAUTER product range. Whatever the project – whether it's the development of customised weighing systems, installation in silos and storage tanks or in shelving for continuous inventory, for special application in mechanical engineering or in any type of test stand – SAUTER can offer you just the right load cell.

Of course, we can also supply you with the appropriate accessories such as load corners, pivot heads, display devices, junction boxes or the relevant calibration certificate at the same time.

Any special requests? Do you need special load cells, other capacities or cable lengths, individual force test stands or a special mount for your test item? No problem, our product specialist for load cells Mr Stefan Herrmann is available at any time to help you and will work with you to develop a customised concept for your application.



Accuracy class	Combined error
C5	≤ 0,01 %
C4	≤ 0,015 %
C3	≤ 0,02 %
C2	≤ 0,03 %
C1	≤ 0,05 %
G1	≤ 0,1 %
G2	≤ 0,2 %
G3	≤ 0,3 %
G5	≤ 0,5 %
G10	≤ 1,0 %



Note

Individual scale construction according to your individual requirements, also possible with third-party components



Stefan Herrmann

Product Specialist

Load Cells

Tel. +49 7433 9933-214

stefan.herrmann@kern-sohn.com

Tip: Analogue torque sensors are compatible with the SAUTER CE HSx display device (rail-mounted module)



Discover more details and matching accessories online!

DC Y1
Static torque sensor
made of alloy steel

Technical data

- High precision (comprehensive Error 0,5 % F.S.)
- RoHS compliant
- For monitoring or measurement of static torques, tests of manual torque wrenches or transfer of static load torques
- Nominal sensitivity: 1,0~1,5 mV/V, depending on nominal load
- Supply voltage max. 10 V DC
- 4-wire connection
- Simple and quick installation
- High torsional stiffness
- Cable length approx. 2 m

DC Y2
Static torque sensor
made of alloy steel

Technical data

- High precision (comprehensive Error 0,5 % F.S.)
- RoHS compliant
- Protection against dust and water splashes IP65 (in accordance with EN 60529)
- For monitoring or measurement of static torques, tests of manual torque wrenches or transfer of static load torques
- Nominal sensitivity: 1,5 mV/V
- Supply voltage max. 15 V DC
- 4-wire connection
- High torsional stiffness
- Cable length approx. 2 m

Other designs and nominal loads on request

STANDARD



STANDARD



OPTION



Model	Nominal load	Price excl. of VAT ex works €
SAUTER	Nm	
DC 5-Y1	5	290,-
DC 10-Y1	10	285,-
DC 20-Y1	20	285,-
DC 50-Y1	50	285,-
DC 100-Y1	100	285,-
DC 200-Y1	200	285,-
DC 500-Y1	500	360,-

Model	Nominal load	Price excl. of VAT ex works €
SAUTER	Nm	
DC 200M-Y2	0,2	490,-
DC 1-Y2	1	490,-
DC 10-Y2	10	490,-
DC 20-Y2	20	490,-
DC 50-Y2	50	490,-



CP P4 · CP Y4
Single-point load cell
made of anodised aluminium

Technical data

- CP P4: Accuracy in accordance with OIML R60 C3
- CP Y4: Accuracy in accordance with OIML R60 C2
- CE and RoHS compliant
- Protection against dust and water splashes IP65 (in accordance with EN 60529)
- Aluminium, anodised
- Suitable for price-computing scales, bench scales, platform scales, etc.
- Maximum platform size: 200×200 mm
- Nominal sensitivity: 0,9 mV/V
- 4-wire connection
- Cable length approx. 0,4 m

CP P1 · CP Y1
Single-point load cell
made of anodised aluminium

Technical data

- CP P1: Accuracy in accordance with OIML R60 C3
- CP Y1: Accuracy in accordance with OIML R60 C2
- CE and RoHS compliant
- Protection against dust and water splashes IP65 (in accordance with EN 60529)
- Aluminium, anodised
- Suitable for price-computing scales, bench scales, platform scales, etc.
- Maximum platform size: 250×350 mm
- Nominal sensitivity: 2 mV/V
- 4-wire connection

CP P3
Single-point load cell
made of anodised aluminium

Technical data

- Accuracy in accordance with OIML R60 C3
- CE and RoHS compliant
- Protection against dust and water splashes IP65 (in accordance with EN 60529)
- Aluminium, anodised
- Suitable for price-computing scales, bench scales, platform scales, etc.
- Maximum platform size: 350×400 mm
- Nominal sensitivity: 2 mV/V
- 4-wire connection
- Cable length approx. 3 m

10

STANDARD: IP 65, 1 DAY
 OPTION: DAKKS, ISO

STANDARD: IP 65, M, 1 DAY
 OPTION: DAKKS, ISO
CP P1

STANDARD: IP 65, 1 DAY
 OPTION: DAKKS, ISO

Model	Nominal load kg	Price excl. of VAT ex works €
SAUTER		
CP 300-0P4	0,3	65,-
CP 600-0P4	0,6	65,-
ECO design		
CP 300-0Y4	0,3	55,-
CP 1500-0Y4	1,5	55,-
CP 3000-0Y4	3	55,-

Model	Nominal load kg	Cable length m	Price excl. of VAT ex works €
SAUTER			
CP 3-3P1	3	0,4	60,-
CP 3-2-3P1	3	2	74,-
CP 5-3P1	5	0,4	60,-
CP 6-3P1	6	0,4	60,-
CP 8-3P1	8	0,4	60,-
CP 10-3P1	10	0,4	60,-
CP 10-3-3P1	10	3	78,-
CP 15-3P1	15	0,4	60,-
CP 15-3-3P1	15	3	78,-
CP 20-3P1	20	0,4	60,-
CP 30-3P1	30	0,4	60,-
CP 35-3P1	35	0,4	60,-
CP 35-3-3P1	35	3	78,-
CP 40-3P1	40	0,4	60,-
CP 50-3P1	50	0,4	60,-
CP 50-2-3P1	50	2	74,-
ECO design (without EC type approval)			
CP 3-2Y1	3	0,45	33,-
CP 5-2Y1	5	0,45	33,-
CP 10-2Y1	10	0,45	33,-
CP 15-2Y1	15	0,45	33,-
CP 20-2Y1	20	0,45	33,-
CP 30-2Y1	30	0,45	33,-
CP 100-3-3Y1	100	3	50,-

Model	Nominal load kg	Price excl. of VAT ex works €
SAUTER		
CP 30-3P3	30	76,-
CP 40-3P3	40	76,-
CP 50-3P3	50	76,-
CP 75-3P3	75	76,-
CP 100-3P3	100	77,-

Discover more details and matching accessories online!



CP P2
Single-point load cell
made of aluminium

Technical data

- Accuracy in accordance with OIML R60 C3
- RoHS compliant
- Protection against dust and water splashes IP65 (in accordance with EN 60529)
- Aluminium alloy, anodized
- Suitable for price computing scales, bench scales etc.
- Maximum platform size
100 – 300 kg: 400×400 mm
400 – 500 kg: 450×450 mm
- 4-wire connection
- Nominal sensitivity: 2 mV/V
- Cable length: 2 m
- Version in accordance with OIML R60 C4 or C5 on request

CP P7
Single-Point load cell
made of stainless steel

Technical data

- Accuracy in accordance with OIML R60 C3
- RoHS compliant
- Protection against dust and water splashes IP67 (in accordance with EN 60529)
- Stainless steel
- Area of application: Mass as well as compressive force measurement in harsh environmental conditions
- Suitable for price computing scales, bench scales etc.
- Maximum platform size: 400×400 mm
- 6-wire connection
- Nominal sensitivity: 2 mV/V
- Cable length: 1 m
- Version in accordance with OIML R60 C4 on request

CP P8
Single-point load cell
made of aluminium

Technical data

- Accuracy in accordance with OIML R60 C3
- RoHS compliant
- Protection against dust and water splashes IP65 (in accordance with EN 60529)
- Aluminium alloy, anodized
- Suitable for price computing scales, bench scales etc.
- Maximum platform size: 600×600 mm
- 6-wire connection
- Nominal sensitivity: 2 mV/V
- Cable length: 3 m
- Version in accordance with OIML R60 C4 or C5 on request

Discover more details and matching accessories online!

STANDARD: IP 65, 1 DAY
OPTION: DAkkS, ISO

STANDARD: IP 67, 1 DAY
OPTION: DAkkS, ISO

STANDARD: IP 65, 1 DAY
OPTION: DAkkS, ISO

Model	Nominal load kg	Price excl. of VAT ex works €
SAUTER		
CP 100-3P2	100	81,-
CP 150-3P2	150	81,-
CP 200-3P2	200	81,-
CP 300-3P2	300	81,-
CP 400-3P2	400	81,-
CP 500-3P2	500	81,-

Model	Nominal load kg	Price excl. of VAT ex works €
SAUTER		
CP 30-3P7	30	270,-
CP 50-3P7	50	270,-
CP 75-3P7	75	270,-
CP 100-3P7	100	270,-
CP 150-3P7	150	270,-

Model	Nominal load kg	Price excl. of VAT ex works €
SAUTER		
CP 50-3P8	50	123,-
CP 100-3P8	100	123,-
CP 150-3P8	150	123,-
CP 200-3P8	200	123,-
CP 250-3P8	250	123,-
CP 300-3P8	300	123,-
CP 500-3P8	500	123,-
CP 600-3P8	600	123,-

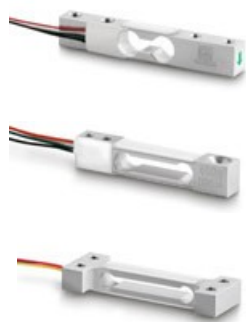

CK P1

CK P2

CK P4



CK Y1



CK Y4

CK P1 · CK P2 · CK P4
Miniature load cell
made of aluminium

Technical data

- High level of accuracy
- Comprehensive error
 CK P1 / CK P2: 0,03 %
 CK P4: 0,05 %
- Protection against dust and water splashes
 IP65 (in accordance with EN 60529)
- Aluminium
- Suitable for small scales and kitchen scales
 and force-measuring devices
- Cable length: 0,25 m

CK Y1 · CK Y4
Flat miniature alloy steel
load cell

Technical data

- Accuracy in accordance with OIML C1
- RoHS compliant
- High precision
 (comprehensive Error 0,05 % F.S.)
- Very low design
- Ideal, for example, for the construction of personal floor scales, kitchen scales, postal scales or other scales with minimal structural height
- Cable length: 0,45 m

CK Y1

- Protection against dust and water splashes
 IP66
- Scope of delivery: 1 piece
- Full bridge circuit(junction box required to connect several measuring cells)

CK Y4

- Protection against dust and water splashes
 IP65
- Scope of delivery: 4 pieces
- Quarter bridge circuit: 4 weighing cells are connected to a full bridge
- No junction box necessary
- No corner adjustment

Discover more details and matching accessories online!

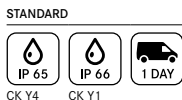

Model	Nominal load	Price excl. of VAT ex works
SAUTER	kg	€
CK 600-0P1	0,6	33,-
CK 1-0P1	1	33,-
CK 2-0P1	2	33,-
CK 3-0P1	3	33,-
CK 5-0P1	5	33,-
CK 6-0P1	6	34,-
CK 300-0P4	0,3	44,-
CK 500-0P4	0,5	44,-

Model	Nominal load	Price excl. of VAT ex works
SAUTER	kg	€
CK 10-Y1	10	23,-
CK 30-Y1	30	23,-
CK 10-Y4	40	23,-
CK 30-Y4	120	25,-
CK 50-Y4	200	25,-



CR Q1
Loadcell
made of stainless steel

Technical data

- Accuracy in accordance with OIML R60 C1
- RoHS compliant
- Protection against dust and water splashes IP68 (in accordance with EN 60529), hermetically encapsulated
- Stainless steel
- Area of application: Measuring mass as well as compressive force
- Suitable for vehicle scales, weigh hoppers, vehicle testing equipment, test stands
- Nominal sensitivity: 2 mV/V
- Cable length 10 m

CR P1
Loadcell
made of stainless steel

Technical data

- Accuracy in accordance with OIML R60 C3
- RoHS compliant
- Protection against dust and water splashes IP68 (in accordance with EN 60529), hermetically encapsulated
- Stainless steel
- Area of application: Measuring mass as well as compressive force
- Suitable for weighbridges, handing scales, silo scales and other types of balances, test stands, etc.
- Nominal sensitivity: 1 – 2 mV/V, depending on nominal load
- Cable length
[Max] ≤ 1000 kg: 3 m
[Max] ≥ 2000 kg: 6 m

CR Y1
Loadcell
made of steel alloy

Technical data

- Accuracy in accordance with OIML R60 C1
- RoHS compliant
- High precision (comprehensive Error 0,05 % F.S.)
- Protection against dust and water splashes IP68 (in accordance with EN 60529), hermetically encapsulated
- Alloy steel
- Area of application: for weight, tensile and compressive force measurement
- Suitable for weight measurement as well as force and force test stands
- Force transmission via pressure piece or threaded hole
- Nominal sensitivity: 2 mV/V
- Cable length: 3 m
- Pressure piece included with delivery
- Thread for pressure piece or other force application: up to 5000 kg M16×1,5, from 10000 kg M32×1,5

10

Discover more details and matching accessories online!

STANDARD: IP 68, 1 DAY
OPTION: ISO
[Max] 25 t/250 kN

STANDARD: IP 68, 4 DAYS
OPTION: DAKKS, ISO
[Max] ≤ 500 kg/5 kN

STANDARD: IP 68, 1 DAY
OPTION: DAKKS, ISO
[Max] ≤ 500 kg/5 kN

Model	Nominal load	Price excl. of VAT ex works €
SAUTER		
CR 2500-1Q1	2,5 t/25 kN	285,-
CR 5000-1Q1	5 t/50 kN	285,-
CR 10000-1Q1	10 t/100 kN	285,-
CR 20000-1Q1	20 t/200 kN	560,-
CR 30000-1Q1	30 t/300 kN	560,-

Model	Nominal load	Price excl. of VAT ex works €
SAUTER		
CR 60-3P1*	60 kg/0,6 kN	600,-
CR 130-3P1*	130 kg/1,3 kN	600,-
CR 250-3P1*	250 kg/2,5 kN	600,-
CR 500-3P1*	500 kg/5 kN	600,-
CR 2000-3P1*	2000 kg/20 kN	600,-

Model	Nominal load	Price excl. of VAT ex works €
SAUTER		
CR 500-1Y1	0,5 t/5 kN	270,-
CR 1000-1Y1	1 t/10 kN	270,-
CR 5000-1Y1	5 t/50 kN	270,-
CR 10000-1Y1	10 t/100 kN	430,-
CR 20000-1Y1	20 t/200 kN	430,-

* ONLY WHILE STOCKS LAST



CB Q1 · CB Q2
Bending beam and shear beam load cell made of stainless steel

Technical data

- Accuracy in accordance with OIML R60 C3
- CE and RoHS compliant
- Protection against dust and water splashes IP68/IP69K (in accordance with EN 60529), welded to create a hermetic seal
- Stainless steel
- Area of application: Measuring mass as well as compressive force in harsh environments
- Suitable for platform scales, weigh hoppers, floor scales and other weighing devices
- 4-wire connection
- Nominal sensitivity: 2 mV/V
- Cable length: 3 m
- Accuracy class OIML R60 C6 or EX version on request

CB P1
Bending beam made of nickel-plated steel

Technical data

- Accuracy in accordance with OIML R60 C3
- CE and RoHS compliant
- Protection against dust and water splashes IP67 (in accordance with EN 60529), hermetically encapsulated
- Nickel-plated steel
- Area of application: Measuring mass as well as compressive force in harsh environments
- Suitable for platform scales, silo scales, bed scales and other types of scales
- 4-wire connection
- Nominal sensitivity: 3 mV/V
- Cable length: 3 m

10

Discover more details and matching accessories online!

STANDARD: IP 68, IP 69K, 1 DAY, DAKkS, ISO
 OPTION: [Max] ≤ 500 kg

STANDARD: IP 67, M, 1 DAY, DAKkS, ISO

Model	Nominal load kg	Price excl. of VAT ex works €
SAUTER		
CB 5-3Q1	5	230,-
CB 10-3Q1	10	230,-
CB 20-3Q1	20	230,-
CB 30-3Q1	30	230,-
CB 50-3Q1	50	230,-
CB 75-3Q1	75	230,-
CB 100-3Q1	100	230,-
CB 150-3Q1	150	230,-
CB 200-3Q1	200	230,-
CB 250-3Q1	250	230,-
CB 300-3Q1	300	230,-
CB 500-3Q1	500	230,-
CB 750-3Q2*	750	240,-
CB 1000-3Q2*	1000	240,-
CB 1500-3Q2*	1500	240,-

Model	Nominal load kg	Price excl. of VAT ex works €
SAUTER		
CB 100-3P1	100	114,-
CB 250-3P1	250	114,-

* ONLY WHILE STOCKS LAST



CT Q1
Shear beam
made of stainless steel

Technical data

- Accuracy in accordance with OIML R60 C3
- CE and RoHS compliant
- Protection against dust and water splashes IP68/IP69K (in accordance with EN 60529), welded to create a hermetic seal
- Stainless steel
- Area of application: Measuring mass as well as compressive force in harsh environments
- Suitable for platform scales, weigh hoppers, flush-mounted floor scales and other weighing devices
- 6-wire connection
- Nominal sensitivity: 2 mV/V
- Cable length: 5 m
- EX version on request

CT P1 · CT P2
Shear beam
made of nickel-plated steel

Technical data

- Accuracy in accordance with OIML R60 C3
- CE and RoHS compliant
- Protection against dust and water splashes IP67 (in accordance with EN 60529), welded to create a hermetic seal
- Nickel-plated steel
- Area of application: Measuring mass as well as compressive force in harsh environments
- Suitable for platform scales, weigh hoppers, flush-mounted floor scales and other weighing devices
- 4-wire connection
- Nominal sensitivity: 3 mV/V
- Cable length
 [Max] ≤ 1000 kg: 4 m
 [Max] ≥ 1500 kg: 6 m
- CT P2: Delivery with calibrated sensitivity, when ordering several cells

10

Discover more details and matching accessories online!

STANDARD

OPTION

[Max] ≤ 500 kg

STANDARD

OPTION

[Max] ≤ 500 kg

Model	Nominal load kg	Price excl. of VAT ex works €
SAUTER		
CT 300-3Q1	300	220,-
CT 500-3Q1	500	220,-
CT 750-3Q1	750	220,-
CT 1000-3Q1	1000	220,-
CT 1500-3Q1	1500	220,-
CT 2000-3Q1	2000	220,-
CT 3000-3Q1	3000	435,-
CT 5000-3Q1	5000	435,-
CT 7500-3Q1	7500	570,-
CT 10000-3Q1	10000	570,-

Model	Nominal load kg	Price excl. of VAT ex works €
SAUTER		
CT 500-3P1	500	98,-
CT 1000-3P1	1000	98,-
CT 1500-3P1	1500	98,-
CT 2500-3P1	2500	119,-
CT 3000-3P1	3000	119,-
CT 5000-3P1	5000	119,-
CT 10000-3P1	10000	173,-
CT 500-3P2	500	103,-
CT 1000-3P2	1000	103,-
CT 5000-3P2	5000	124,-
CT 3000-3P2	3000	125,-
CT 10000-3P2	10000	178,-



CS P1
4-wire “S” measuring cell
made of nickel-plated steel for
force and mass measurement

Technical data

- Accuracy in accordance with OIML R60 C3
- RoHS compliant
- Protection against dust and water splashes IP67 (in accordance with EN 60529), welded to create a hermetic seal
- Nickel-plated steel
- Area of application: for tensile and compressive force measurement
- Suitable for hanging scales, weigh hoppers and other weighing devices as well as force measurement devices and test stands
- **1** 4-wire connection
- Nominal sensitivity: 2 mV/V
- Cable length
 [Max] ≤ 1500 kg: 3 m
 [Max] ≥ 2000 kg: 6 m
- Note: EX version or accuracy class C4 on request

CS Q1
6-wire “S” measuring cell
made of nickel-plated steel for
force and mass measurement

Technical data

- Accuracy in accordance with OIML R60 C3
- RoHS compliant
- Protection against dust and water splashes IP67 (in accordance with EN 60529), hermetically encapsulated
- Nickel-plated steel
- Area of application: for tensile and compressive force measurement
- Suitable for hanging scales, weigh hoppers and other weighing devices as well as force measurement devices and test stands
- **1** 6-wire connection
- Nominal sensitivity: 2 mV/V
- Cable length: 5 m

1 With 6-wire measuring circuits, the cable can be shortened without affecting the temperature compensation and the actual characteristic value. For 4-wire measuring circuits the cable length should not be changed

Discover more details and matching accessories online!

STANDARD OPTION

[Max] ≤ 500 kg/5 kN
 [Max] ≤ 25 t/250 kN

STANDARD OPTION

[Max] ≤ 500 kg/5 kN
 [Max] ≤ 12 t/120 kN

Model	Nominal load	Price excl. of VAT ex works €
SAUTER		
CS 25-3P1	25 kg/0,25 kN	200,-
CS 50-3P1	50 kg/0,5 kN	200,-
CS 100-3P1	100 kg/1 kN	200,-
CS 150-3P1	150 kg/1,5 kN	200,-
CS 250-3P1	250 kg/2,5 kN	200,-
CS 500-3P1	500 kg/5 kN	200,-
CS 600-3P1	600 kg/6 kN	200,-
CS 750-3P1	750 kg/7,5 kN	200,-
CS 1000-3P1	1000 kg/10 kN	230,-
CS 1500-3P1	1500 kg/15 kN	230,-
CS 2000-3P1	2000 kg/20 kN	260,-
CS 2500-3P1	2500 kg/25 kN	260,-
CS 5000-3P1	5000 kg/50 kN	260,-
CS 7500-3P1	7500 kg/75 kN	530,-
CS 10000-3P1	10000 kg/100 kN	530,-
CS 15000-3P1	15000 kg/150 kN	690,-
CS 20000-3P1	20000 kg/200 kN	760,-
CS 30000-3P1	30000 kg/300 kN	1950,-

Model	Nominal load	Price excl. of VAT ex works €
SAUTER		
	kg	
CS 50-3Q1	50 kg/0,5 kN	215,-
CS 100-3Q1	100 kg/1 kN	215,-
CS 150-3Q1	150 kg/1,5 kN	215,-
CS 200-3Q1	200 kg/2 kN	215,-
CS 300-3Q1	300 kg/3 kN	215,-
CS 500-3Q1	500 kg/5 kN	215,-
CS 750-3Q1	750 kg/7,5 kN	215,-
CS 1000-3Q1	1000 kg/10 kN	215,-
CS 1500-3Q1	1500 kg/15 kN	250,-
CS 2000-3Q1	2000 kg/20 kN	250,-
CS 3000-3Q1	3000 kg/30 kN	370,-
CS 5000-3Q1	5000 kg/50 kN	370,-
CS 6000-3Q1	6000 kg/60 kN	370,-



CO Y1



CO Y2/CO Y3



CO Y4



CS Y1 Miniature "S"-load/force measuring cell made of stainless steel

Technical data

- High precision (comprehensive Error 0,05 % F.S.)
- Accuracy in accordance with OIML C1
- RoHS compliant
- Protection against dust and water splashes IP65
- Stainless steel
- Area of application: Tensile and compressive applications, mass and force measurement
- Suitable for force test stands, hanging scales, silo scales and various other balances
- 4-wire connection
- Nominal sensitivity: 1,3 – 2 mV/V, depending on nominal load
- Cable length: 2 m

CO Y1 · CO Y2 · CO Y3 · CO Y4 Miniature cylindrical load cell made of stainless steel

Technical data

- RoHS compliant
 - Suitable for weight measurement as well as force and force test stands
 - 4-wire connection
- CO Y1 · CO Y4**
- High precision (comprehensive Error 0,5 % F.S.)
 - Accuracy in accordance with OIML G5
 - Area of application: Compressive applications
 - Nominal sensitivity: 1,0 – 1,5 mV/V, depending on nominal load
- CO Y2 · CO Y3**
- High level of accuracy, Comprehensive error CO Y2: 0,5 % F. S. | CO Y3: 0,1 % F. S.
 - Accuracy in accordance with OIML G5 (CO Y2) | G10 (CO Y3)
 - Area of application: Tensile and compressive applications
 - Nominal sensitivity: 1,5 – 2 mV/V, depending on nominal load
 - Cable length: 2 m

CO Y5 Tension and compression force measuring cell made of stainless steel

Technical data

- Accuracy in accordance with OIML R60 G1
- CE and RoHS compliant
- Protection against dust and water splashes IP66 (in accordance with EN 60529)
- Stainless steel
- Very low design
- Suitable for test stands, force gauges, automation systems, etc.
- 4-wire connection
- Nominal sensitivity: CO 0.5-Y5, CO 1-Y5: 1 mV/V
CO 5-Y5, CO 10-Y5: 2 mV/V
- Cable length: 2 m



Model	Nominal load	Price excl. of VAT ex works €
SAUTER		
CS 1-Y1	1 kg/10 N	345,-
CS 2-Y1	2 kg/20 N	345,-
CS 5-Y1	5 kg/50 N	345,-
CS 10-Y1	10 kg/100 N	345,-
CS 20-Y1	20 kg/200 N	345,-

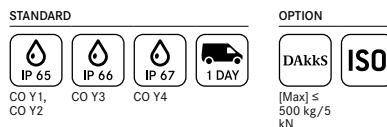

Model	Nominal load	Price excl. of VAT ex works €
SAUTER		
CO 10-Y1	10 kg/100 N	170,-
CO 20-Y1	20 kg/200 N	170,-
CO 50-Y1	50 kg/500 N	170,-
CO 100-Y1	100 kg/1 kN	170,-
CO 200-Y1	200 kg/2 kN	170,-
CO 500-Y1	500 kg/5 kN	200,-
CO 1000-Y1	1000 kg/10 kN	200,-
CO 2000-Y1	2000 kg/20 kN	235,-
CO 10-Y2	10 kg/100 N	250,-
CO 20-Y2	20 kg/200 N	250,-
CO 50-Y2	50 kg/500 N	250,-
CO 100-Y2	100 kg/1 kN	310,-
CO 200-Y2	200 kg/2 kN	310,-
CO 500-Y2	500 kg/5 kN	310,-
CO 1000-Y2	1000 kg/10 kN	310,-
CO 2000-Y2	2000 kg/20 kN	345,-
CO 5-Y3*	5 kg/50 N	380,-
CO 10-Y3*	10 kg/100 N	380,-
CO 5-Y4*	5 kg/50 N	235,-
CO 10-Y4*	10 kg/100 N	230,-

* ONLY WHILE STOCKS LAST

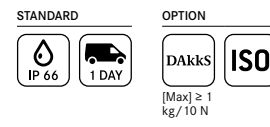

Model	Nominal load	Price excl. of VAT ex works €
SAUTER		
CO 0.5-Y5	500 g/5 N	365,-
CO 1-Y5	1 kg/10 N	365,-
CO 5-Y5	5 kg/50 N	365,-
CO 10-Y5	10 kg/100 N	365,-

Discover more details and matching accessories online!



CJ P4



CJ P4PG



CJ X467



CJ X468

CJ P
Junction box for the connection of several measuring cells to an evaluation unit

Features

- Prepared for 4-wire and 6-wire measuring cells
- The robust aluminium diecast housing
- Protection against dust and water splashes

CJ X
Junction box for the connection of several measuring cells to an evaluation unit

Features

- Prepared for 4-wire and 6-wire measuring cells

CJ X467

- Robust housing made of stainless steel with IP67 dust and spray protection

CJ X468

- The robust aluminium diecast housing, Protection against dust and water splashes IP68

Discover more details and matching accessories online!

STANDARD



Model	Number of connection options	Price excl. of VAT ex works €
SAUTER		
CJ P4	4	87,-
CJ P4PG	4	98,-

STANDARD



Model	Number of connection options	Price excl. of VAT ex works €
SAUTER		
CJ X468	4	130,-
CJ X467	4	220,-

Accredited Calibration with Calibration Certificate for Force Gauges

The KERN calibration laboratory is at your side when you need to calibrate with accreditation reliably. From the transducer to the full measuring chain, we are happy to take care of traceable calibration of your test equipment for you. Our accreditation includes the calibration of tensile and compressive force up to 5 kN according to the standards DIN EN ISO 376 and DKD-R 3-3, each with the Newton (N) display unit for a complete measuring chain (situation A) or voltage ratio/transmission coefficient (mV/V, situation B).

Below you will find a comparison of which standard meets which criteria:

Comparison of DIN EN ISO 376 and DKD-R 3-3

	ISO 376	DKD-R 3-3
Standardization	ISO standard (internationally standardized)	Standard of the DKD (Germany)
Measuring equipment	Force transducers and complete measuring chains	Force transducers and complete measuring chains
Area of application	Specifically force gauges for the testing of testing equipment	General force gauges
Number of power stages	8	5
Classification/Assessment	Classification in classes 00; 0,5; 1 and 2	None in standard
Test sequences	Fixed procedure	Processes A, B, C and D possible. Standard is A; B, C and D are reduced processes, corresponding previous knowledge is necessary
Summary	Higher-quality calibration, as 8 force levels are calibrated	High-quality calibration, reduced sequences with less effort possible

Prices for accredited Recalibration of Force Gauges and Force Transducers

Situation A: Force transducer (voltage ratio, in mV/V) *1,2

ISO 376 (8 stages)			DKD-R 3-3 (5 stages, sequence A)		
KERN	Measuring range	Price € ex works excl. of VAT	KERN	Measuring range	Price € ex works excl. of VAT
Tensile force:					
963-161IVR	≤ 500 N	270,-	963-161VR	≤ 500 N	255,-
963-162IVR	≤ 2 kN	325,-	963-162VR	≤ 2 kN	300,-
963-163IVR	≤ 5 kN	420,-	963-163VR	≤ 5 kN	390,-
Compression force:					
963-261IVR	≤ 500 N	270,-	963-261VR	≤ 500 N	255,-
963-262IVR	≤ 2 kN	325,-	963-262VR	≤ 2 kN	300,-
963-263IVR	≤ 5 kN	420,-	963-263VR	≤ 5 kN	390,-
Tensile and Compression force:					
963-361IVR	≤ 500 N	455,-	963-361VR	≤ 500 N	420,-
963-362IVR	≤ 2 kN	540,-	963-362VR	≤ 2 kN	500,-
963-363IVR	≤ 5 kN	720,-	963-363VR	≤ 5 kN	660,-

Situation B: Complete force gauge (in N) *2

ISO 376 (8 stages)			DKD-R 3-3 (5 stages, sequence A)		
KERN	Measuring range	Price € ex works excl. of VAT	KERN	Measuring range	Price € ex works excl. of VAT
Tensile force:					
963-161IR	≤ 500 N	220,-	963-161R	≤ 500 N	200,-
963-162IR	≤ 2 kN	270,-	963-162R	≤ 2 kN	245,-
963-163IR	≤ 5 kN	375,-	963-163R	≤ 5 kN	340,-
Compression force:					
963-261IR	≤ 500 N	220,-	963-261R	≤ 500 N	200,-
963-262IR	≤ 2 kN	270,-	963-262R	≤ 2 kN	245,-
963-263IR	≤ 5 kN	375,-	963-263R	≤ 5 kN	340,-
Tensile and Compression force:					
963-361IR	≤ 500 N	305,-	963-361R	≤ 500 N	365,-
963-362IR	≤ 2 kN	495,-	963-362R	≤ 2 kN	455,-
963-363IR	≤ 5 kN	670,-	963-363R	≤ 5 kN	600,-

R = Recalibration

For each force gauge without interface or from other manufacturers we charge a surcharge for the additional effort.

*1 Compatibility with our amplifiers required

*2 Installation in our measuring equipment required

Factory Calibration Certificates

As DAKKS-accredited calibration certificates cannot be offered for all measuring devices or measurement sizes, or where it is not customary, we then offer factory calibration certificates. This is not an accredited calibration (no proof of metrological traceability). These calibrations are carried out according to in-house specifications and are available for many measuring instruments, such as:

- Mechanical balances (spring balances, etc.)
- Force-measuring devices up to 250 kN
- Measuring devices for layer thickness 0 µm – 2000 µm
- Hardness testing devices in accordance with Leeb tests
- Ultrasonic material thickness testing device 25 mm – 300 mm

We carry out calibrations independent of brand. In order to avoid any unnecessary delays when processing your order, please send us the technical documents and necessary accessories with the checking device. Calibration time 4 working days.

For up-to-date information on test services for further measuring sizes, please visit our website www.kern-lab.com

Factory Calibration for Force

Situation A: Force transducer (voltage ratio, in mV/V) *1,2			Situation B: Complete force gauge (in N) *2		
KERN	Measuring range	Price excl. of VAT ex works €	KERN	Measuring range	Price excl. of VAT ex works €
Tensile force:					
961-161VR	≤ 500 N	255,-	961-161R	≤ 500 N	200,-
961-162VR	≤ 2 kN	300,-	961-162R	≤ 2 kN	245,-
961-163VR	≤ 5 kN	390,-	961-163R	≤ 5 kN	340,-
961-164VR	≤ 20 kN	495,-	961-164R	≤ 20 kN	445,-
961-165VR	≤ 50 kN	495,-	961-165R	≤ 50 kN	445,-
961-166VR	≤ 120 kN	530,-	961-166R	≤ 120 kN	490,-
961-167VR	≤ 250 kN	530,-	961-167R	≤ 250 kN	490,-
Compression force:					
961-261VR	≤ 500 N	255,-	961-261R	≤ 500 N	200,-
961-262VR	≤ 2 kN	300,-	961-262R	≤ 2 kN	245,-
961-263VR	≤ 5 kN	390,-	961-263R	≤ 5 kN	340,-
961-264VR	≤ 20 kN	495,-	961-264R	≤ 20 kN	445,-
961-265VR	≤ 50 kN	495,-	961-265R	≤ 50 kN	445,-
961-266VR	≤ 120 kN	530,-	961-266R	≤ 120 kN	490,-
961-267VR	≤ 250 kN	530,-	961-267R	≤ 250 kN	490,-
Tensile and Compression force:					
961-361VR	≤ 500 N	420,-	961-361R	≤ 500 N	365,-
961-362VR	≤ 2 kN	500,-	961-362R	≤ 2 kN	455,-
961-363VR	≤ 5 kN	660,-	961-363R	≤ 5 kN	600,-
961-364VR	≤ 20 kN	710,-	961-364R	≤ 20 kN	660,-
961-365VR	≤ 50 kN	710,-	961-365R	≤ 50 kN	660,-
961-366VR	≤ 120 kN	780,-	961-366R	≤ 120 kN	720,-
961-367VR	≤ 250 kN	780,-	961-367R	≤ 250 kN	720,-

R = Recalibration

For each force gauge without interface or from other manufacturers we charge a surcharge for the additional effort.

*1 Compatibility with our amplifiers required

*2 Installation in our measuring equipment required

Factory Calibration Certificates

KERN	Physical unit	Measuring range	Price excl. of VAT ex works €
Factory calibration			
961-102KR	Force (for digital dynamometer KERN MAP)	≤ 130 kg	180,-
961-110R	Coating thickness	≤ 2000 µm F or N	180,-
961-112R	Coating thickness	≤ 2000 µm FN	255,-
961-113R	Wall thickness (ultra sound)	≤ 300 mm (in stainless steel)	180,-
961-170R	Hardness comparison plate (Shore)	For sets up to 7 plates	143,-
961-131R	Hardness tester (Leeb)	400 – 800 HLD	180,-
961-132R	Hardness comparison plate (Leeb)	Hardness comparison plate (for Leeb durometer)	180,-
961-270R	Hardness (UCI)	200 – 800 HV	390,-
961-150R	Length	≤ 300 mm	180,-
961-190R	Light	≤ 200000 lx	350,-
961-100R	Mass (Mechanical balances/ spring balances)	≤ 5 kg	107,-
961-101R	Mass (Mechanical balances/ spring balances)	> 5 – 50 kg	133,-
961-102R	Mass (Mechanical balances/ spring balances)	> 50 – 350 kg	158,-
961-103R	Mass (Mechanical balances/ spring balances)	> 350 – 1500 kg	245,-
961-120R	Torque wrench test devices	1 Nm – 200 Nm	255,-

Additional services

962-116R	Express service with 48 hour delivery	55,-/ instrument
----------	---------------------------------------	------------------

Retailer Information

Sales conditions

All prices are valid as of January 1st 2026, Subject to change without notice. Current prices at www.kern-sohn.com. In Europe, all prices do not include the applicable V.A.T.

Delivery Conditions

We supply ex works Balingen, e.g. the transport costs are invoiced. With our contract logistics partners we always offer you shipping at a good rate. When shipping to islands or other more distant areas, or areas which are difficult to access, the transport costs may possibly be higher, please ask for details. Any goods supplied remain KERN's property until complete payment for the goods sold has been received.



Delivery is usually via courier service.



When you see this symbol by truck, please ask for prices.

Extract from general terms and conditions

Court of jurisdiction/Legal domicile:

72336 Balingen, Germany;
Commercial register N°: HRB 400865,
AG Stuttgart; Managing director: Albert Sauter
For the full Terms and Conditions,
please refer to the website.

<https://www.kern-sohn.com/shop/en/IMPRESSUM/AGB2/>

All dimensions are approximate. Technical changes in the course of further development, printing faults, price changes and product changes are likely in individual cases, due to product modifications as well as error.

Sale or return

within 14 days of purchase. Not valid for Software and order-specific adaptations such as special productions, cable extensions, special weights, etc. or test services such as calibration, verification, etc. Depending on the time and effort involved, there may be processing and storage costs, please ask for details.

Warranty

→ 3 years for products with list price \geq € 500.00

→ 2 years for components as well as products with list price $<$ € 500.00

→ 1 year for pallet truck scales

Does not apply to consumables such as batteries, rechargeable battery packs, etc.

Service

KERN DirectCash

The quick, secure COD procedure for protection against non-payment. With the KERN DirectCash COD system, you can safely deliver orders to end customers with unknown credit rating, with no risk of non-payment. Please request further details on this procedure.

Hire Purchase

Financing is available using KERN hire purchase – easy and convenient. Hire Purchase gives you the option of purchasing any product from our range against a simple monthly installment. The product value is financed over the period of the agreement. On payment of the last installment, the ownership of the contract item automatically transfers from the contractor to the contractee. The Hire Purchase Agreement can – if you so choose – be set for a period of between one and five years. This package includes the transfer of items as well as the guarantee for the entire transfer period.

Compared with buying the product, KERN hire purchase offers the advantage that the initial financial investment is largely unnecessary. This is particularly relevant when purchasing a number of products, for example when refitting a laboratory, a company department or a hospital ward. In addition the monthly installments constitute a direct cost and the item does not have to be capitalised by the purchaser.

After-Sales-Service

Repair service

Within 1 week at our plant in Balingen, transportation costs are additional. In urgent cases, if requested by customer, a replacement device will be provided until all repairs are completed; please ask.

Price reduction for a new device

If repair costs exceed the current value of the defective device, a new device will be offered for a discount price. This offer is valid only up to 2 years after warranty expiration.

Spare parts service

Usually within 48 hours, transportation costs are additional.

Marketing support

KERN catalogues, brochures, branch prospectuses – your own personalised marketing tools

This catalogue and branch prospectuses are available free of charge. A neutral version of the catalogue, without the KERN address imprint, is also available free of charge for your marketing activities as PDF document. The KERN catalogue and branch prospectuses are available in the following languages: DE, EN, FR, IT, ES.

Calibration Certificate with accreditation symbol

Upon request, you will receive a Calibration Certificate with accreditation symbol (Deutsche Akkreditierungsstelle GmbH – German accreditation point), for many SAUTER measuring instruments. This certificate documents the precision of the respective instrument in detail and also serves as your proof that you monitor your checking equipment in a Quality Management System to ISO 9001.

Accessories

Further extensive accessories for all our models can also be found in the KERN online shop www.kern-sohn.com

The oldest Precision Balance Factory in Germany

SAUTER GmbH

c/o KERN & SOHN GmbH

Ziegelei 1

72336 Balingen

Germany

Tel. +49 7433 9933-0

info@sauter.eu

www.kern-sohn.com

Discover the diverse World of Measurement Technology and Testing Services from SAUTER online:

www.kern-sohn.com

- Full SAUTER & KERN Product Range
- Extensive Information and useful Download Options
- Useful KERN Services
- Convenient 24/7 Ordering
- Technical Product Data Sheets
- Technical Glossary
- Selection of more than 5,000 Items across Measuring and Weighing Technology, Optical Instruments as well as Accessories and Services
- Operating Instructions
- KERN Dealer Portal
- Descriptive Image and Video Material
- Practical Filter and Search Functions



Follow us on our Social Media Channels too



CONFORMITY
ASSESSMENT
ACCORDING TO
NAWID:
2014/31/EU

